



Digital Projector User Manual

Home Cinema Series | W5800

V 1.01

Warranty and Copyright information

Limited warranty

BenQ warrants this product against any defects in material and workmanship, under normal usage and storage.

Proof of purchase date will be required with any warranty claim. In the event this product is found to be defective within the warranty period, BenQ's only obligation and your exclusive remedy shall be replacement of any defective parts (labor included). To obtain warranty service, immediately notify the dealer from which you purchased the product of any defects.

IMPORTANT: The above warranty shall be void if the customer fails to operate the product in accordance with BenQ's written instructions, especially the ambient humidity must be in-between 10% and 90%, temperature in-between 0°C and 35°C, altitude lower than 4920 feet, and avoiding to operate the projector in a dusty environment. This warranty gives you specific legal rights, and you may have other rights which vary from country to country.

For other information, please visit www.BenQ.com.

Copyright

Copyright 2024 by BenQ Corporation. All rights reserved. No part of this publication may be reproduced, transmitted, transcribed, stored in a retrieval system or translated into any language or computer language, in any form or by any means, electronic, mechanical, magnetic, optical, chemical, manual or otherwise, without the prior written permission of BenQ Corporation.

Disclaimer

BenQ Corporation makes no representations or warranties, either expressed or implied, with respect to the contents hereof and specifically disclaims any warranties, merchantability or fitness for any particular purpose. Further, BenQ Corporation reserves the right to revise this publication and to make changes from time to time in the contents hereof without obligation to notify any person of such revision or changes.

*DLP, Digital Micromirror Device and DMD are trademarks of Texas Instruments. Others are copyrights of their respective companies or organizations.

Table of Contents

Warranty and Copyright information	2
Important safety instructions	4
Introduction	8
Package contents	8
Projector exterior view	9
Terminal	11
Controls and functions	12
Positioning your projector	14
Choosing a location	14
Obtaining a preferred projected image size.....	15
Mounting the projector.....	16
Adjusting the projector position.....	18
Adjusting the projected image.....	19
Connection	21
Operations	22
Starting up the projector	22
Using the menus	24
Securing the projector	25
Switching input signal	25
Presented from a Media Reader	26
Upgrades the firmware	27
Shutting down the projector	28
Menu operation	29
Basic Menu	29
Advanced Menu	30
Maintenance	48
Care of the projector.....	48
Light Source Information	49
Troubleshooting	52
Specification	53
Projector specifications.....	53
Dimensions.....	54
Timing chart	55
RS232 command.....	57

Important safety instructions

Your projector is designed and tested to meet the latest standards for safety of information technology equipment. However, to ensure safe use of this product, it is important that you follow the instructions mentioned in this manual and marked on the product.

1. **Please read this user manual before you operate your projector.**

Save it for future reference.

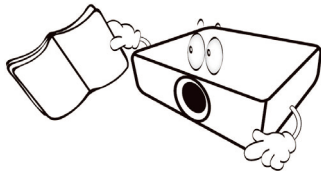

2. **Do not look straight at the projector lens during operation.**

It may harm your sight.

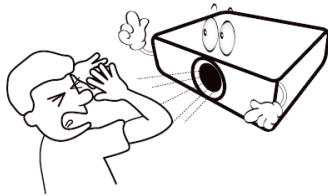

3. **Refer servicing to qualified service personnel.**

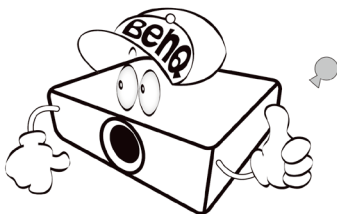

4. **Always remove the lens cap when the projector light source is on.**

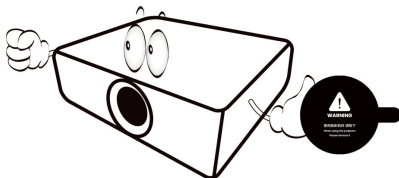

5. **The light source becomes extremely hot during operation.**

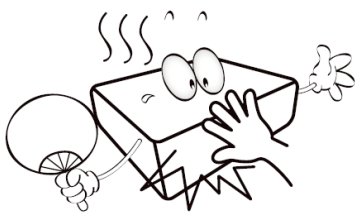

6. In some countries, the line voltage is NOT stable. This projector is designed to operate safely within a mains voltage between 100 to 240 volts AC, but could fail if power cuts or surges of ± 10 volts occur.

In areas where the mains voltage may fluctuate or cut out, it is recommended that you connect your projector through a power stabilizer, surge protector or uninterruptible power supply (UPS).

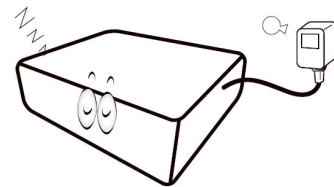

7. **Do not block the projection lens with any objects when the projector is under operation as this could cause the objects to become heated and deformed or even cause a fire. To temporarily turn off the light source, press the **ECO BLANK** button.**

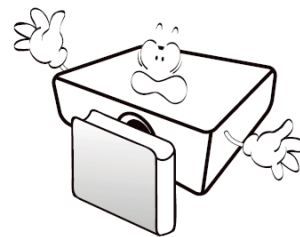

8. **Do not operate light sources beyond the rated light source life.**

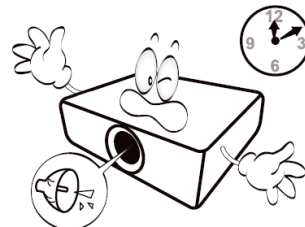

9. Do not place this product on an unstable cart, stand, or table. The product may fall, sustaining serious damage.

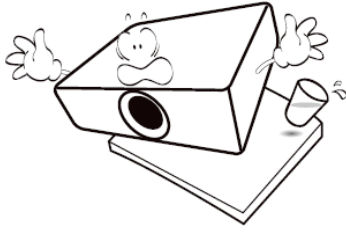

10. Do not attempt to disassemble this projector. There are dangerous high voltages inside which may cause death if you should come into contact with live parts.

Under no circumstances should you ever undo or remove any other covers. Refer servicing only to suitably qualified professional service personnel.

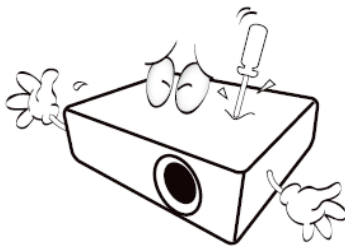

11. Do not block the ventilation holes.
- Do not place this projector on a blanket, bedding or any other soft surface.
 - Do not cover this projector with a cloth or any other item.
 - Do not place inflammables near the projector.



If the ventilation holes are seriously obstructed, overheating inside the projector may result in a fire.

12. Always place the projector on a level, horizontal surface during operation.

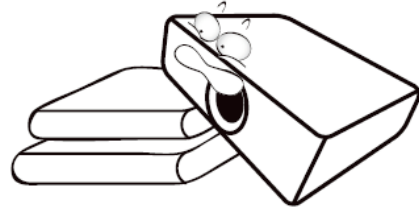

13. Do not stand the projector on end vertically. Doing so may cause the projector to fall over, causing injury or resulting in damage to the projector.

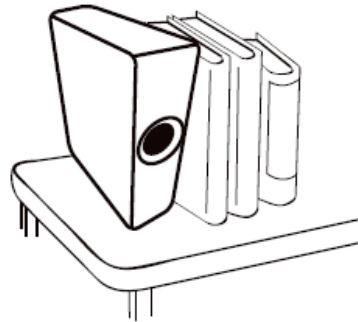

14. Do not step on the projector or place any objects upon it. Besides probable physical damage to the projector, doing so may result in accidents and possible injury.



15. When the projector is under operation, you may sense some heated air and odor from its ventilation grill. It is a normal phenomenon and not a product defect.

16. Do not place liquids near or on the projector. Liquids spilled into the projector may cause it to fail. If the projector does become wet, disconnect it from the power supply's power outlet and call BenQ to have the projector serviced.

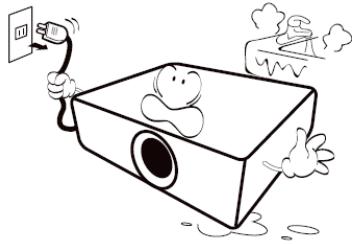

17. This product is capable of displaying inverted images for ceiling mount installation.

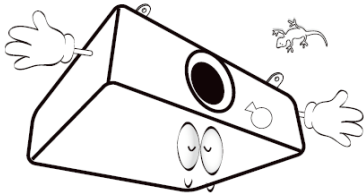

18. This apparatus must be earthed.

19. To avoid damaging the DLP chips, never aim a high-power laser beam into the projection lens.

20. Do not place this projector in any of the following environments.

Poorly ventilated or confined space can significantly increase noise levels. **Allow at least 50 cm clearance from walls and free flow of air around the projector.**

Locations where temperatures may become excessively high, such as the inside of a car with all windows rolled up. Locations where excessive humidity, dust, or cigarette smoke may contaminate optical components, shorten the projector's life span and darken the image.

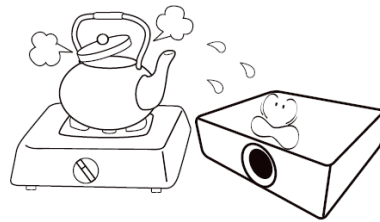

Locations near fire alarms.

Locations with an ambient temperature above 40°C/ 104°F.

Locations where the altitudes are higher than 2000 m.

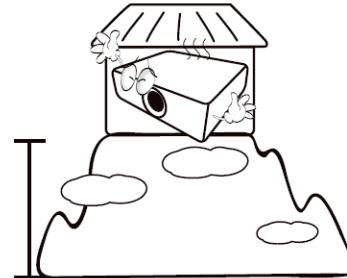

NOTICE

To ensure safe use of this product, please read the user manual carefully before you operate the projector.

Risk Group 2

1. According to the classification of photobiological safety of light source and light source systems, this product is Risk Group, IEC 62471-5:2015.
2. Possibly hazardous optical radiation emitted from this product.
3. Do not stare at operating light source, it may harm your sight.
4. As with any bright source, do not stare into the direct beam.



laser warning

This product belongs to CLASS 1 consumer laser product and complies with IEC 60825-1:2014, EN 60825-1:2014/A11:2021 and EN 50689:2021.



Caution - Use of controls or adjustments or performance of procedures other than those specified herein may result in hazardous radiation exposure.

- Notice is given to supervise children and to never allow them to stare into the projector beam at any distance from the projector.
- Notice is given to use caution when using the remote control for starting the projector while in front of the projection lens.
- Notice is given to the user to avoid the use of optical aids such as binoculars or telescopes inside the beam.

Introduction

Package contents

Carefully unpack and verify that you have all of the items shown below. If any of these items are missing, please contact your place of purchase.

Standard accessories

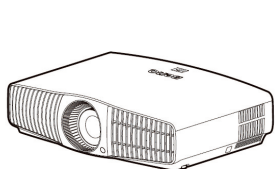

Projector

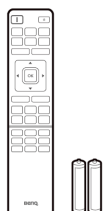

Remote controls with
batteries

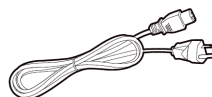

Power cord

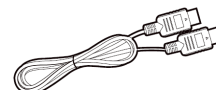

HDMI cable

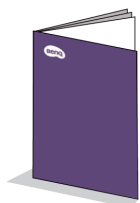

Quick Start Guide



Warranty Card

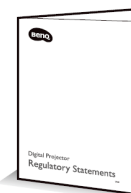

Regulatory statements



Calibration Report



- The supplied accessories will be suitable for your region, and may differ from those illustrated.
- * The warranty card is only supplied in some specific regions. Please consult your dealer for detailed information.

Optional accessories

- BenQ 3D glasses
- Universal wall mount

Replacing the remote control batteries

1. Press and slide off the battery cover, as illustrated.
2. Remove the old batteries (if applicable) and install two AAA batteries. Make sure that the positive and negative ends are positioned correctly, as illustrated.
3. Slide the battery cover in until it clicks into place.

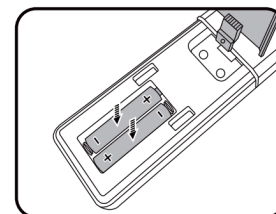
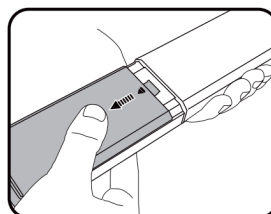



- Avoid leaving the remote control and batteries in an excessively hot or humid environment like the kitchen, bathroom, sauna, sunroom or in a closed car.
- Replace only with the same or equivalent type recommended by the battery manufacturer.
- Dispose of the used batteries according to the manufacturer's instructions and local environment regulations for your region.
- Do not throw the battery into a fire as this may cause it to explode.
- If the batteries are dead or if you will not be using the remote control for an extended period of time, remove the batteries to avoid damage to the remote control from possible battery leakage.
- Risk of explosion if the battery is replaced by an incorrect type.
- Disposal of a battery into fire or a hot oven, or mechanically crushing or cutting of a battery, that can result in an explosion.
- Leaving a battery in an extremely high temperature surrounding environment that can result in an explosion or the leakage of flammable liquid or gas.
- A battery subjected to extremely low air pressure that may result in an explosion or the leakage of flammable liquid or gas.

Projector exterior view

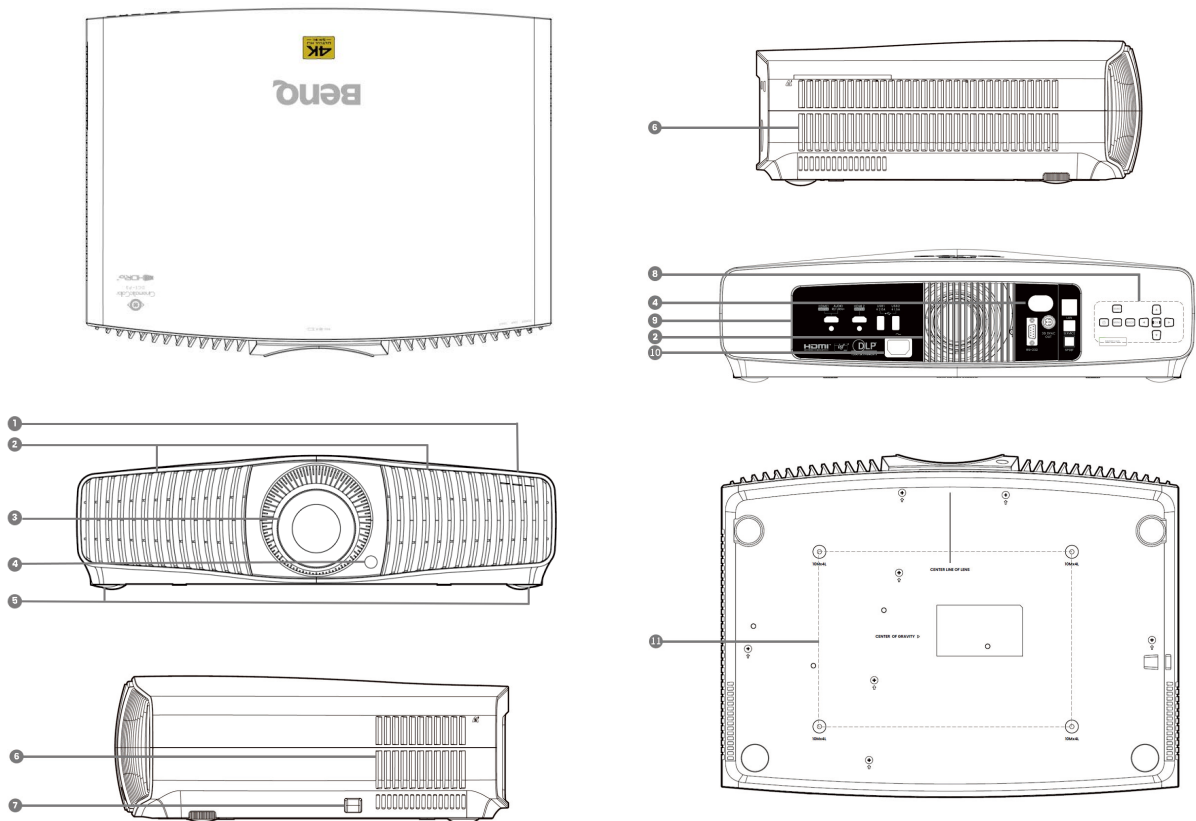

-
1. LED Indicators
 2. Vent (air inlet)
 3. Projection lens
 4. IR remote sensor
 5. Adjuster feet
 6. Vent (air exhaust)
 7. Anti-theft security bar
 8. External control panel
Refer to ["Controls and functions" on page 12.](#)
 9. Connector panel
Refer to ["Terminal" on page 11.](#)
 10. AC power jack
 11. Ceiling mount holes

Terminal

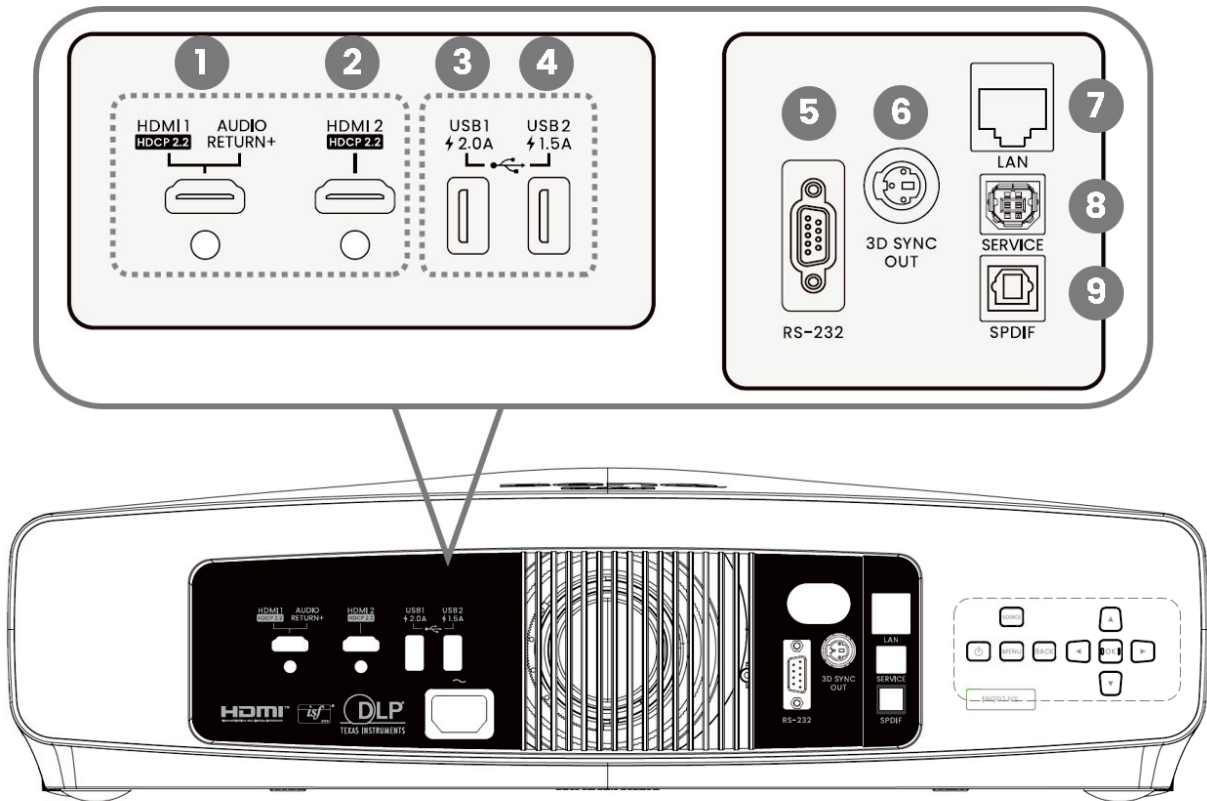

1. HDMI input connector (Version 2.1, Audio Return)
2. HDMI input connector (Version 2.1 FRL)
3. USB 2.0 Type-A port (2.0 A, Media Reader, Firmware upgrade)
4. USB 2.0 Type-A port (1.5 A, Media Reader, Firmware upgrade)
5. RS232 control port
6. 3D Sync Signal output port
7. RJ-45 LAN input connector (Direct Connect)
8. USB Type-B port (Service)
9. SPDIF audio output port

Controls and functions

Projector & Remote control



All the key presses described in this document are available on the remote control or projector.

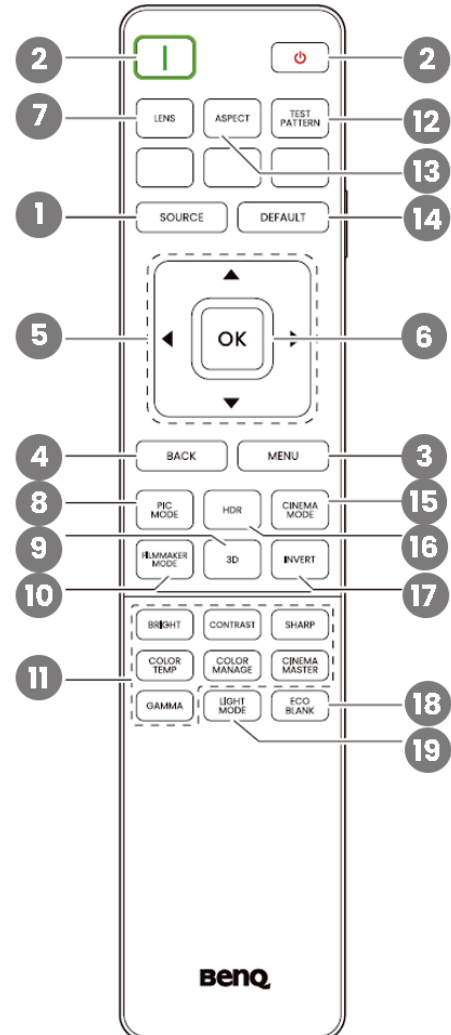
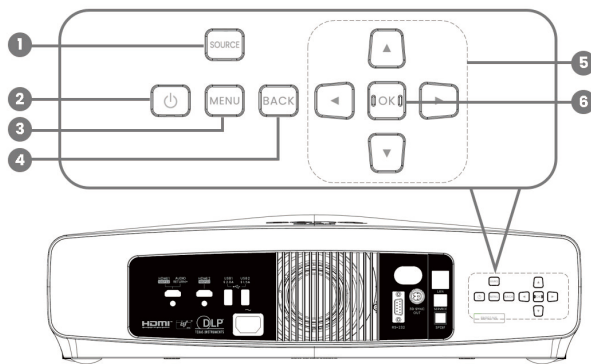

1. SOURCE

A source selection bar appears.

2. POWER

Toggles the projector between standby mode and on.

3. MENU

Turns on/off the On-Screen Display (OSD) menu.

4. BACK

Goes back to previous OSD menu, exits and saves menu settings.

5. Arrow keys

When the On-Screen Display (OSD) menu is activated, these keys are used as 4 directional arrows to select the desired menu items and to make adjustments.

When OSD menu is inactive, workable under CEC-capable sources only.

6. OK
Confirms the selected On-Screen Display (OSD) menu item.
7. LENS
The lens control menu is displayed.
8. PIC MODE
Displays the picture mode menu.
9. 3D
Displays the 3D menu.
10. FILMMAKER MODE
Switch to FILMMAKER MODE.
11. Picture quality adjustment keys (BRIGHT, CONTRAST, SHARP, COLOR TEMP, COLOR MANAGE, CINEMA MASTER, GAMMA)
Display the setting bars for adjustments of the appropriate picture quality values.
12. TEST PATTERN
Displays the test pattern.
13. ASPECT
Selects the display aspect ratio.
14. DEFAULT
Resets the current function to its default factory setting.
15. CINEMA MODE
Switch to cinema mode.
16. HDR
Display the setting bars of the HDR brightness values.
17. INVERT
3D signal reversal.
18. ECO BLANK
Used to hide the screen image.
19. LIGHT MODE
Selects a suitable light power from among the provided modes.

Remote control effective range

The remote control must be held at an angle within 30 degrees perpendicular to the projector's IR remote control sensor(s) to function correctly. The distance between the remote control and the sensor(s) should not exceed 8 meters (~ 26 feet).

Make sure that there are no obstacles between the remote control and the IR sensor(s) on the projector that might obstruct the infra-red beam.

- Operating the projector from the front side
- Operating the projector from the rear

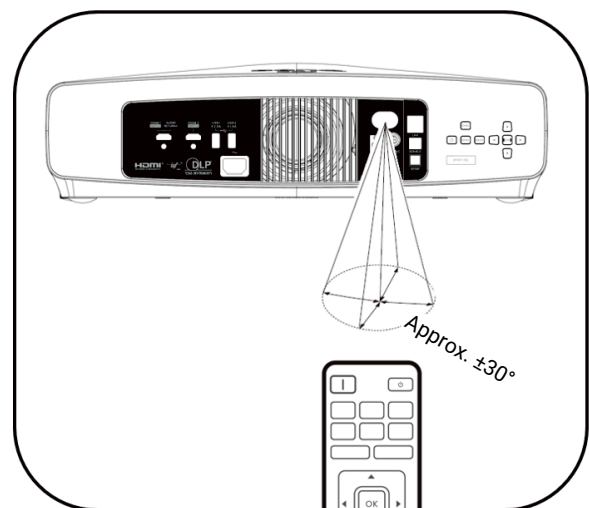
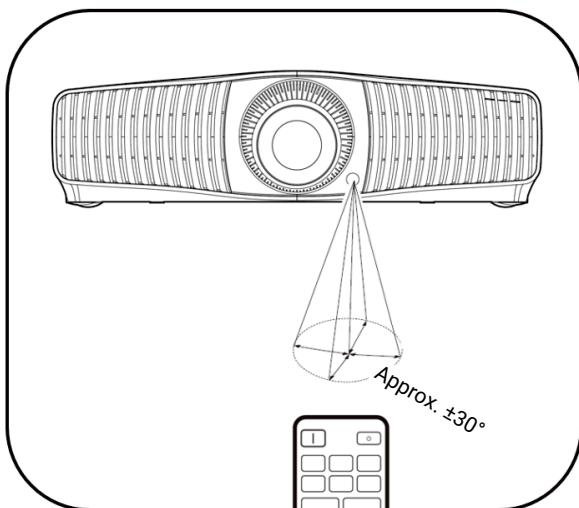

Positioning your projector

Choosing a location

Before choosing an installation location for your projector, take the following factors into consideration:

- Size and position of your screen
- Electrical outlet location
- Location and distance between the projector and the rest of your equipment

The projected image size and vertical offset depend on how far you place the projector, and the zoom setting you choose. See "[Projection screen size](#)" on page 15 for more information. It can help you decide exact distance and height of your projector.

You can install your projector in the following ways.

1. Front

Select this location with the projector placed on the table in front of the screen. This is the most common way to position the projector for quick setup and portability.

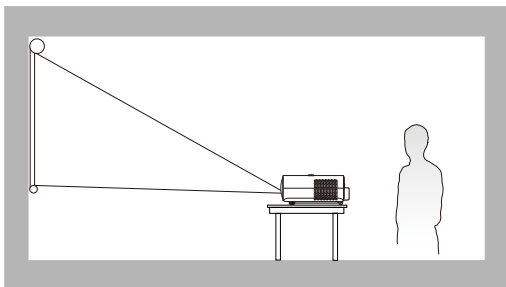

2. Front Ceiling

Select this location with the projector suspended upside-down from the ceiling in front of the screen. Purchase the BenQ Projector Ceiling Mount Kit from your dealer to mount your projector on the ceiling.

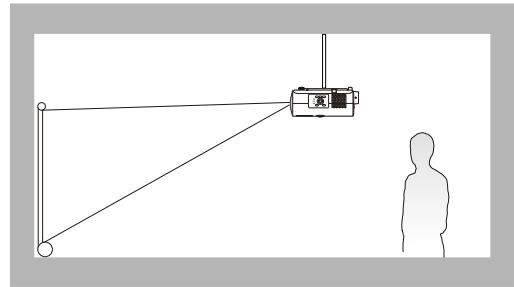

3. Rear

Select this location with the projector placed on the table behind the screen. Note that a special rear projection screen is required.

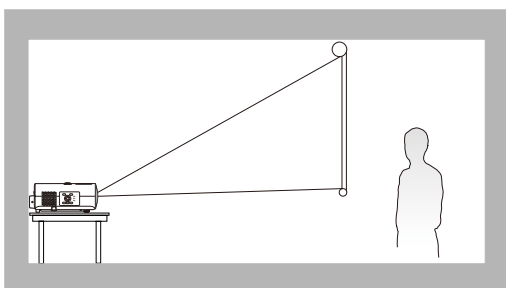

4. Rear Ceiling

Select this location with the projector suspended upside-down from the ceiling behind the screen. Note that a special rear projection screen and the BenQ Projector Ceiling Mount Kit are required for this installation location.

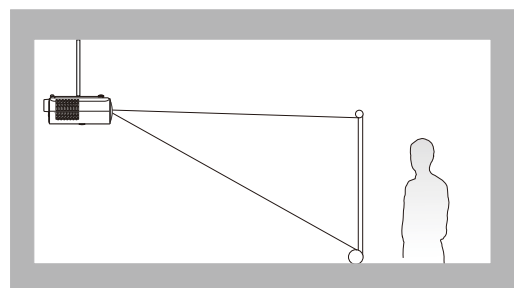

After turning on the projector, go to **Advanced** menu - **Installation** > **Projector Position**, press **OK** and press **◀/▶** to select a setting.

Obtaining a preferred projected image size

The distance from the projector lens to the screen, the zoom setting, and the video format each factors in the projected image size.

Projection screen size

- The screen aspect ratio is 16:9 and the projected picture is in a 16:9 aspect ratio

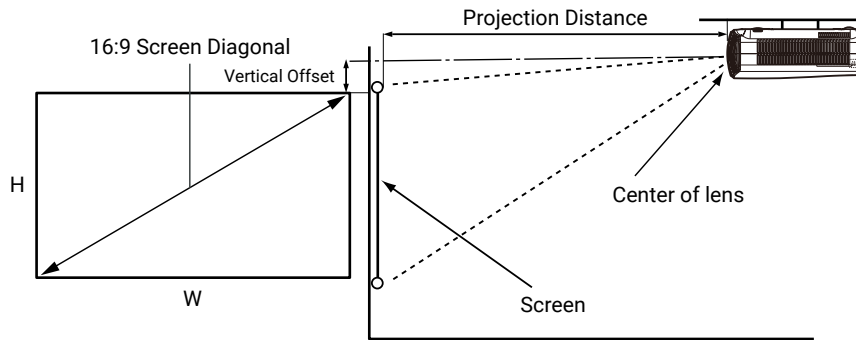

*The vertical offset value is the vertical distance from the top edge of the image (when the projector is ceiling mounted, diagram on the right) to the centerline of lens.

Screen Size				Distance from screen (mm)			Vertical offset (Lowest/Highest lens position) (mm)
Diagonal		H (mm)	W (mm)	Min length (max. zoom)	Average	Max length (min. zoom)	
Inches	mm						
60	1524	747	1328	2019	2636	3254	0
80	2032	996	1771	2692	3515	4339	0
95	2413	1183	2103	3197	4174	5152	0
100	2540	1245	2214	3365	4395	5424	0
120	3048	1494	2657	4039	5274	6510	0
150	3810	1868	3321	5048	6592	8136	0
180	4572	2241	3985	6057	7910	9763	0
200	5080	2491	4428	6731	8790	10849	0
250	6380	3113	5535	8413	10987	13561	0
300	7620	3736	6641	10094	13182	16270	0

For example, if you are using a 120-inch screen, the recommended projection distance is 5274 mm.

If your measured projection distance is 440 cm, the closest match in the "Distance from screen (mm) column" is 4395 mm.

Looking across this row shows that a 100" (about 2.5 m) screen is required. The projected image will be slightly lower than the lens centerline with 1245 mm vertical offset.



- To optimize your projection quality, we suggest doing the projection by referring to the values listed in the non-gray rows.



- All measurements are approximate and may vary from the actual sizes. BenQ recommends that if you intend to permanently install the projector, you should physically test the projection size and distance using the actual projector in situ before you permanently install it, so as to make allowance for this projector's optical characteristics. This will help you determine the exact mounting position so that it best suits your installation location.
-

Mounting the projector

If you intend to mount your projector, we strongly recommend that you use a proper fitting BenQ projector mounting kit and that you ensure it is securely and safely installed.

If you use a non-BenQ brand projector mounting kit, there is a safety risk that the projector may fall down due to an improper attachment through the use of the wrong gauge or length screws.

Before mounting the projector

- Purchase a BenQ projector mounting kit from the place you purchased your BenQ projector.
- BenQ recommends that you also use a security cable to secure both the base of the mounting bracket and the security bar on the projector. This will perform the secondary role of restraining the projector should its attachment to the mounting bracket become loose.
- Ask your dealer to install the projector for you. Installing the projector on your own may cause it to fall and result in injury.
- Take necessary procedures to prevent the projector from falling off such as during an earthquake.
- The warranty doesn't cover any product damage caused by mounting the projector with a non-BenQ brand projector mounting kit.
- Consider the surrounding temperature where the projector is ceiling mounted. If a heater is used, the temperature around the ceiling may be higher than expected.
- Read the user manual for the mounting kit about the range of torque. Tightening with torque exceeding the recommended range may cause damage to the projector and subsequently falling off.
- Make sure the power outlet is at an accessible height so that you can easily shut down the projector.

Ceiling/Wall mount installation diagram

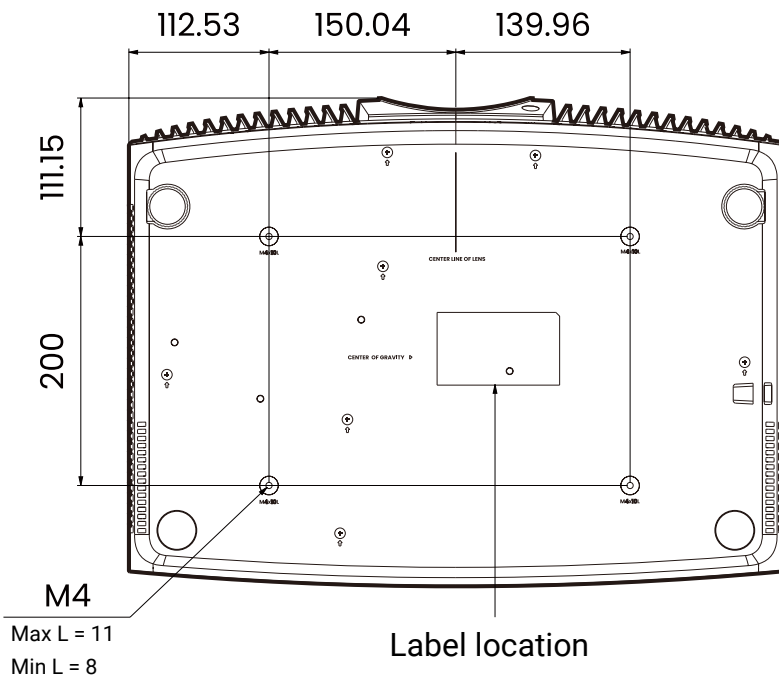

Ceiling/Wall mount screw: M4
Max. L = 11 mm
Min. L = 8 mm

Unit: mm

Adjusting the projector position

Shifting the projection lens

The lens shift provides flexibility for installing your projector. When the Lens Shift is enabled, you can position the projector off center from the screen. The lens shift range is expressed as a percentage of half of the height or width of the projected image. You may use the direction arrow keys to adjust the position of the projected picture within the allowable range depending on your desired image position under the Lens Shift function.

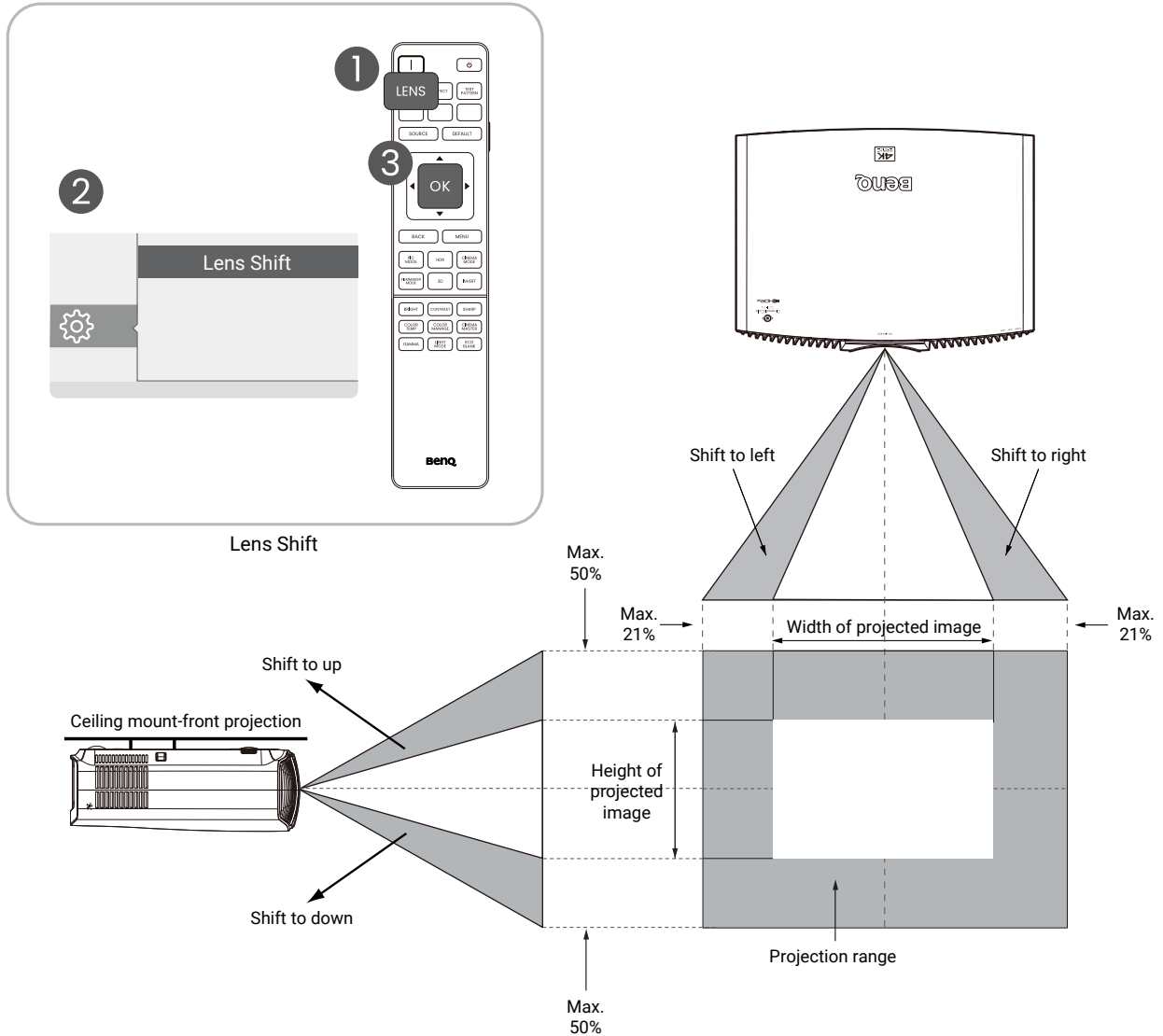

- Lens shift adjustment will not result in a degraded picture quality.
- There are tolerances in the lens shift range. Both vertical and horizontal shift range tolerances are $\pm 5\%$.

Adjusting the projected image

Adjusting the projection angle

If the projector is not placed on a flat surface or the screen and the projector are not perpendicular to each other, the projected image becomes trapezoidal.

You can screw the adjuster feet to fine-tune the horizontal angle.

To retract the feet, screw the adjuster feet in a reverse direction.

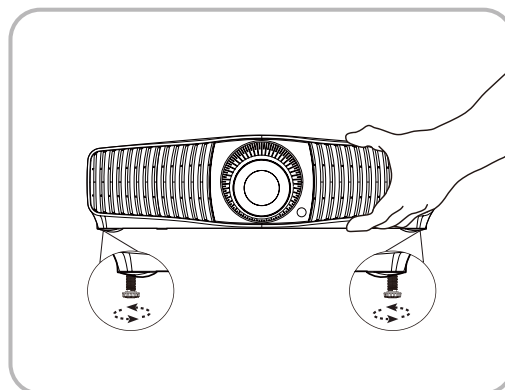

• Do not look into the lens while the light source is on. The strong light from the light source may cause damage to your eyes.

Fine-tuning the image size and clarity

Use the Focus & Zoom functions in the Lens Control and adjust with the arrow keys.

A diagram showing two examples of image adjustments. The first example shows a blurry image of a building on the left, followed by a right-pointing arrow, and then a sharp image of the same building on the right. Below this is a left-right arrow icon and the text 'Adjust Focus' with a sub-note '* Adjusts the clarity of the image'. The second example shows a smaller image of the building on the left, followed by a double-headed horizontal arrow, and then a larger image of the same building on the right. Below this is a double-headed vertical arrow icon and the text 'Adjust Zoom' with a sub-note '* Adjusts the size of the image'.

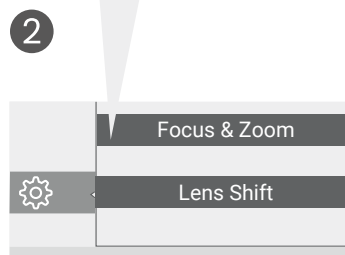
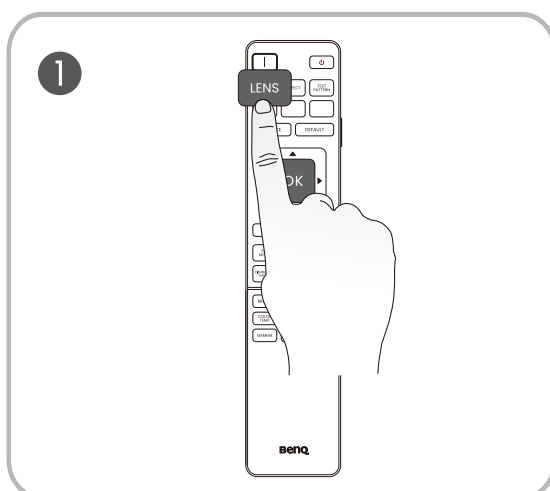

Correcting keystone

Keystoning refers to the situation where the projected image becomes a trapezoid due to angled projection.

To correct the distorted image:

1. Display the **2D Keystone** correction page from the following menus.
 - The setup wizard during the projector initial setup.
 - The **Basic** menu system.
 - The **Installation** menu of the **Advanced** menu system.

2. After the **2D Keystone** correction page appears:

- To correct keystone at the top of the image, use ▼.
- To correct keystone at the bottom of the image, use ▲.
- To correct keystone at the right side of the image, use ◀.
- To correct keystone at the left side of the image, use ▶.
- To reset the keystone values, please press **BACK** for 2 seconds.
- To automatically correct the vertical sides of the distorted image, press **OK** for 2 seconds.

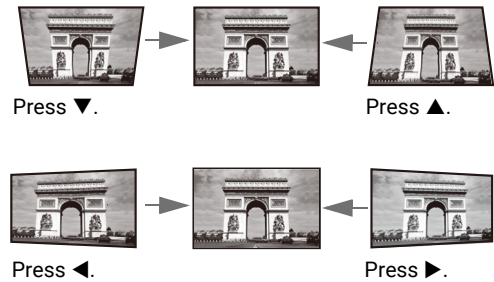

3. When done, press **BACK** to save the changes and exit.

Connection

When connecting a signal source to the projector, be sure to:

1. Turn all equipment off before making any connections.
2. Use the correct signal cables for each source.
3. Make sure the cables are firmly inserted.

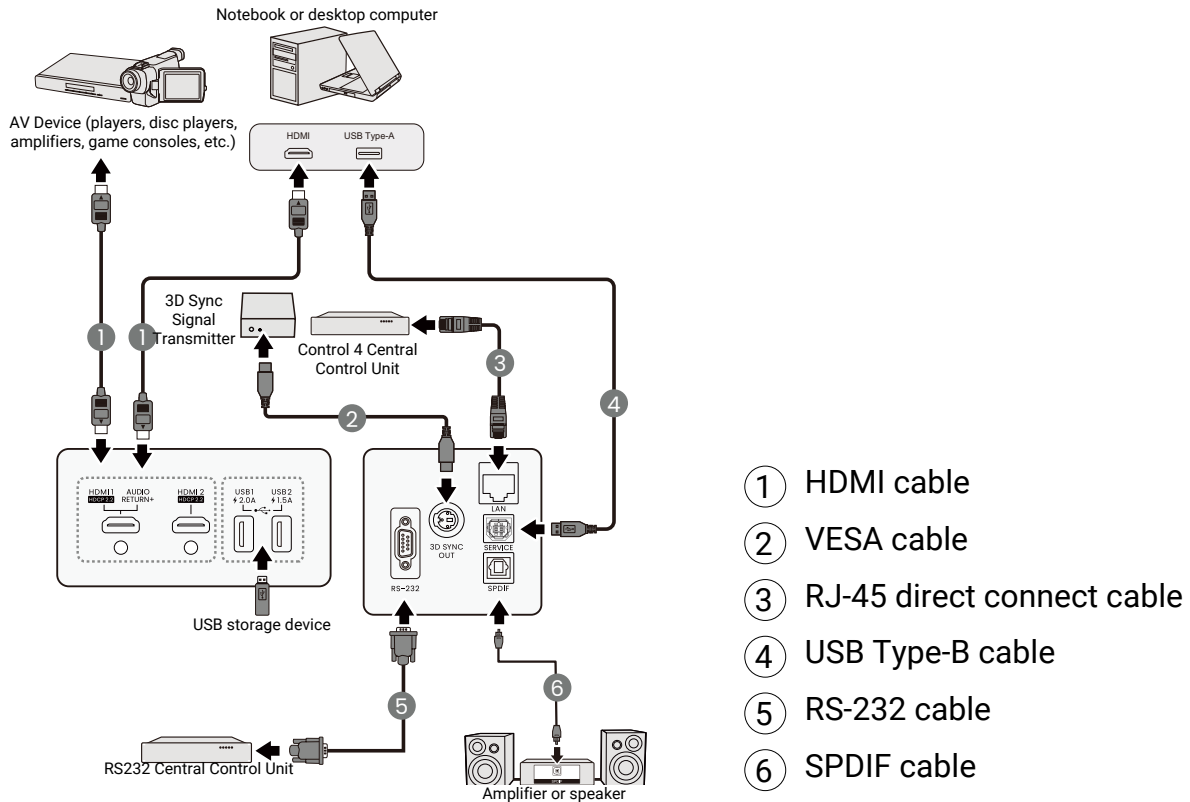

- In the connections above, some cables may not be included with the projector (see ["Package contents" on page 8](#)). They are commercially available from electronics stores.
- The connection illustrations are for reference only. The rear connecting jacks available on the projector vary with each projector model.
- Many notebooks do not turn on their external video ports when connected to a projector. Usually a key combo like FN + function key with a monitor symbol turns the external display on/off. Press FN and the labeled function key simultaneously. Refer to your notebook's documentation to find your notebook's key combination.
- If the selected video image is not displayed after the projector is turned on and the correct video source has been selected, check that the video source device is turned on and operating correctly. Also check that the signal cables have been connected correctly.

Operations

Starting up the projector

1. Plug the power cord. Turn on the power outlet switch (where fitted). The power indicator on the projector lights orange after power has been applied.
2. Press the power button on the projector or remote control to start the projector. The power indicator flashes green and stays green when the projector is on. The start up procedure takes about 20 seconds. In the later stage of starting up, a start-up logo is projected.
3. If this is the first time you turn on the projector, the setup wizard appears to guide you through setting up the projector. If you have already done this, skip this step and move on to the next step.
 - Use the arrow keys on the projector or remote control to move through the menu items.
 - Use OK to confirm the selected menu item.

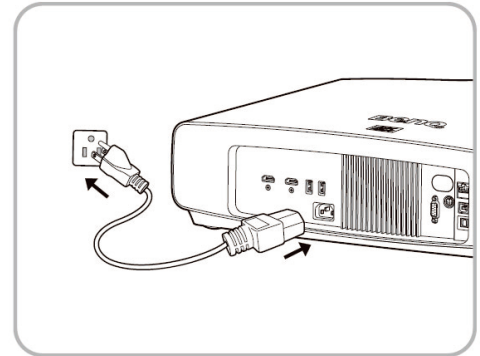

Step 1:

Specify Projector Position.

For more information about projector position, see ["Choosing a location" on page 14.](#)

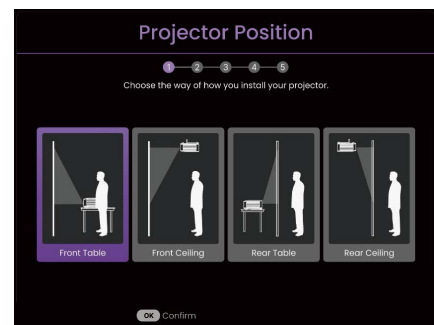

Step 2:

Please adjust the focus.

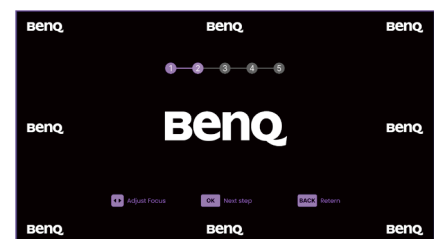

Step 3:

Specify OSD Language.

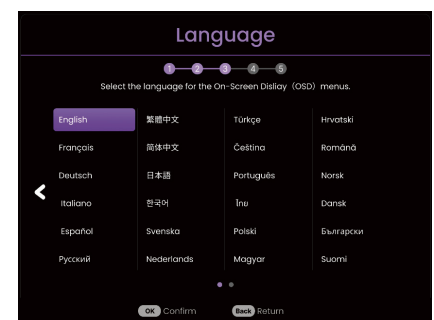

Step 4:

Please adjust the Lens Shift/Focus & Zoom.

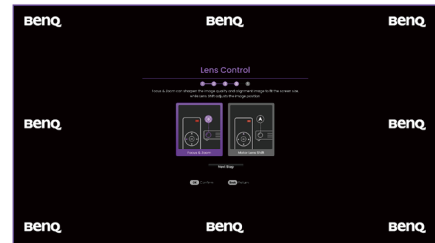

Step 5:

Adjust the 2D Keystone as needed.

For more information about keystone, see ["Correcting keystone" on page 20](#).

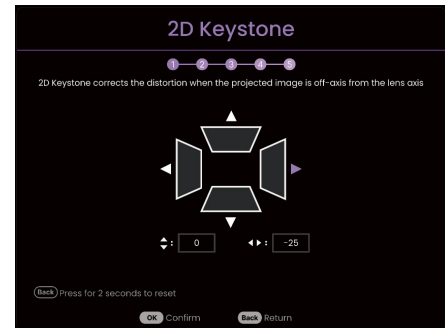

4. Switch all of the connected equipment on.
5. The projector will search for input signals. The current input signal being scanned appears. If the projector does not detect a valid signal, the message "No Signal" will appear until an input signal is found.
You can also press SOURCE to select your desired input signal. Refer to ["Switching input signal" on page 25](#).



- Please use the original accessories (e.g. power cord) to avoid possible dangers such as electric shock and fire.
- If the projector is still hot from previous activity, it will run the cooling fan for approximately 90 seconds before energizing the light source.



- The Setup Wizard screenshots are for reference only and may differ from the actual design.
 - If the frequency/resolution of the input signal exceeds the projector's operating range, the projection will not display the picture. Please change to an input signal which is compatible with the projector's resolution or set the input signal to a lower setting. Refer to ["Timing chart" on page 55](#).
 - If no signal is detected for 3 minutes, the projector automatically enters the ECO BLANK mode.
-

Using the menus

The projector is equipped with 2 types of On-Screen Display (OSD) menus for making various adjustments and settings. The **Basic** OSD menu provides primary menu functions while the **Advanced** OSD menu provides full menu functions.

To access the OSD menu, press **MENU** on the projector or remote control.

- Use the arrow keys (**▲/▼/◀/▶**) on the projector or remote control to move through the menu items.
- Use **OK** on the projector or remote control to confirm the selected menu item.

The first time you use the projector (after finishing the initial setup), press **MENU**, and the **Basic** OSD menu will be displayed.

If you intend to switch from the **Basic** OSD menu to the **Advanced** OSD menu:

1. Go to **Menu Type** and press **OK**.
2. Use **▲/▼** to select **Advanced**, then press **OK**. Your projector will switch to the **Advanced** OSD menu.

Likewise, when you wish to switch from the **Advanced** OSD menu to the **Basic** OSD menu, follow the instructions below:

1. Go to **System > Menu Settings > Menu Type**, and then press **OK**.
2. Use **▲/▼** to select **Basic**, then press **OK**. Your projector will switch to the **Basic** OSD menu.

Overview of the **Basic** OSD menu.

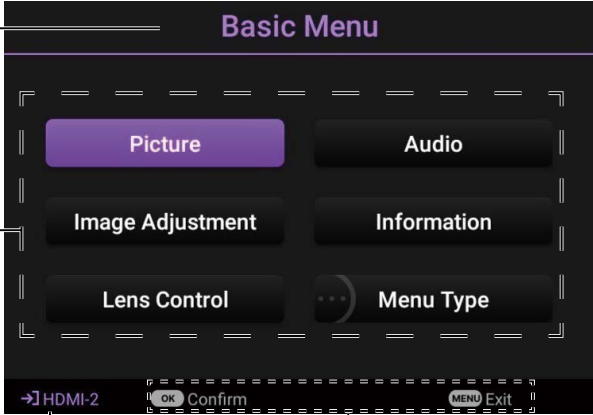

The screenshot shows the 'Basic Menu' interface. At the top, it says 'Basic Menu'. Below this, there are several menu items: 'Picture' (highlighted in purple), 'Audio', 'Image Adjustment', 'Information', 'Lens Control', and 'Menu Type'. At the bottom, there is a status bar showing 'HDMI-2', 'OK Confirm', and 'MENU Exit'. Numbered callouts 1 through 4 point to these specific elements.

- ① Menu Type
- ② Sub-menu and status
- ③ Current input signal
- ④ Function keys

Overview of the **Advanced** OSD menu.

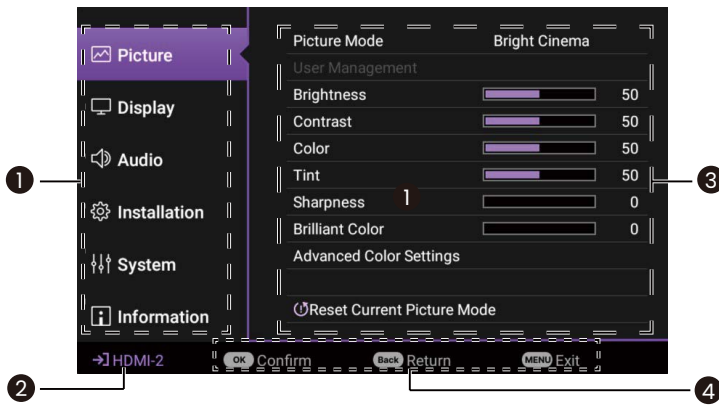

- 1 Main menu
- 2 Current input signal
- 3 Sub-menu and status
- 4 Function keys



The OSD screenshots are for reference only, and may differ from the actual design.

Securing the projector

The projector has to be installed in a safe place to prevent theft. Otherwise, purchase a security cable to secure the projector. A security bar is located on the right side of the projector. See item 7 on [page 10](#). Insert a security cable to the opening of the security bar and secure it to a nearby fixture or heavy furniture.

Switching input signal

The projector can be connected to multiple devices at the same time. However, it can only display one full screen at a time. When starting up, the projector automatically searches for the available signals.

To manually select the source:

1. Press **SOURCE**. A source selection bar appears.
2. Press **▲/▼** until your desired signal is selected and press **OK**.

Once detected, the picture from the selected source will appear. If there is multiple equipment connected to the projector, repeat steps 1-2 to search for another signal.

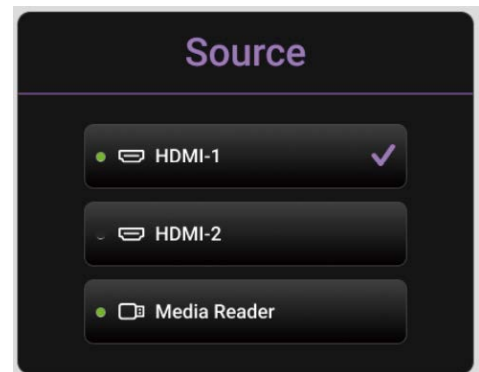

- The brightness level of the projected image will change accordingly when you switch between different input signals.
- For best display picture results, you should select and use an input signal which outputs at the projector's native resolution. Any other resolutions will be scaled by the projector depending upon the "aspect ratio" setting, which may cause some image distortion or loss of picture clarity. See "[Aspect Ratio](#)" on [page 38](#).

Presented from a Media Reader

The MEDIA READER (USB) port on the projector allows you to browse the image and document files stored on a USB flash drive connected to the projector. It can eliminate the need for a computer source.

Supported File Formats

Music	Video	Photo
<ul style="list-style-type: none">• MP3 (.mp3)• MP2 (.mp2)• M4A (.m4a)• Lossless (.flac)• WAV (.wav)	<ul style="list-style-type: none">• AVI (.avi)• MOV (.mov)• MPEG program stream (.mpg, .mp4)• 3GP (.3gp, .3g2)• ASF (.asf)• VOB (.vob)• DAT (.dat)• TS (.ts)• MPEG-4 (.m4v)• FLV (.flv)	<ul style="list-style-type: none">• JPG/JPEG• BMP• PNG

Viewing files

1. Plug the USB flash drive into the **MEDIA READER** port on the back of the projector.
2. Press **SOURCE** to highlight **Media Reader**. The projector displays the built in media reader main page.
3. Press ◀/▶, select the USB stick, and then press **OK** to access your local hard drive.
4. Select a folder or a file you want to display and press **OK**.
5. After a file is displayed, press **OK** to call out the function bar. You can press ◀/▶ to select the function and press **OK** to enact the selected item.

Upgrades the firmware



To ensure a smooth process, please perform the following steps before upgrading the firmware.

1. Check and write down your firmware version from the **Information > Firmware Version** menu.
2. Call BenQ service center to provide the version number and verify the projector is free from firmware compatibility problem.

1. Go to BenQ website and enter **Product page > Support > Software** to download the latest firmware file.
2. There is no need to unzip the downloaded file and save it to the root directory of the USB flash drive. (It is recommended to use a USB flash drive in FAT32 format)
3. Plug the USB flash drive into the **USB** port on the back of the projector.

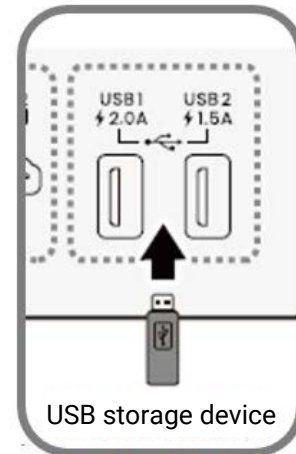

4. Go to **Advanced Menu > System > Firmware Upgrade** Menu, then press **OK**.

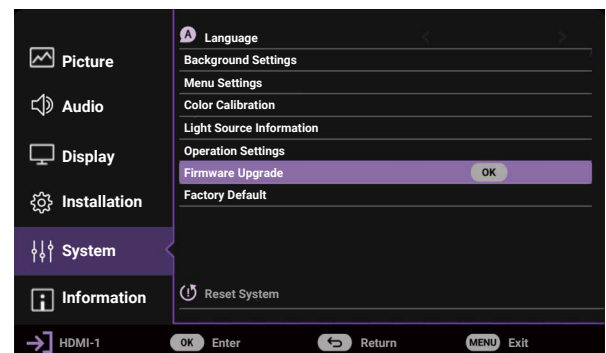

5. Select **Yes** to upgrade the firmware version. Keep the projector power on until the firmware upgrade is finished.

Shutting down the projector

1. Press POWER and a confirmation message will display prompting you. If you don't respond in a few seconds, the message will disappear.
2. Press the power button again. The power indicator flashes orange, the projection light source shuts down, and the fans will continue to run for approximately 10 seconds to cool down the projector.
3. Once the cooling process finishes, the power indicator becomes a steady orange and the fans stop. Disconnect the power cord from the power outlet.

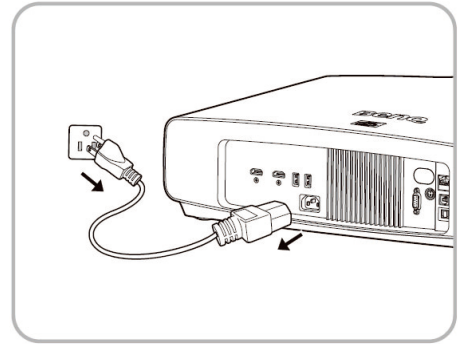

To protect the light source, the projector will not respond to any commands during the cooling process.

Menu operation

Please note that the on-screen display (OSD) menus vary according to the signal type selected and the projector model you are using. The menu items are available when the projector detects at least one valid signal. If there is no equipment connected to the projector or no signal detected, limited menu items are accessible.

Basic Menu

Structure

Menu	Options
Image	Picture Mode Bright / Bright Cinema / Cinema / FILMMAKER MODE / 3D / HDR10 / HDR10+ / FILMMAKER MODE (HDR) / HLG / ISF Night / ISF Day / User
	Light Source Mode Normal / ECO / Custom
Audio	Audio Output Audio Return+ / SPDIF
	Audio Output Format RAW / LPCM
Lens Control	Lens Lock On / Off
	Focus & Zoom Arrow keys
	Lens Shift Arrow keys
2D Keystone	H: -35 ~ +35, V: -35 ~ +35
Information	Detected Resolution
	Source
	Picture Mode
	Light Source Mode
	3D Format
	Color System
	Dynamic Range
	Light Source Usage Time
	Firmware Version
	Service Code
Menu Type	Basic / Advanced

Advanced Menu

1. Main menu: **Picture**

Structure

Menu		Options	
Picture Mode		Bright / Bright Cinema / Cinema / FILMMAKER MODE / 3D / HDR10 / HDR10+ / FILMMAKER MODE (HDR) / HLG / ISF Night / ISF Day / User	
User Management	Load Settings From	Bright Cinema / Cinema / FILMMAKER MODE	
	Rename User Mode		
Brightness		0-100	
Contrast		0-100	
Color		0-100	
Tint		0-100	
Sharpness		0-15	
EXTREME COLOR		0-10	
Gamma Selection		1.8 / 2.0 / 2.1 / 2.2 / 2.3 / 2.4 / 2.5 / 2.6 / BenQ	
Color Temperature		Native (for Bright picture mode) Normal / Cool / Warm (for the rest picture modes)	
Advanced Color Settings	Color Temperature Tuning	R Gain / G Gain / B Gain	0-200
		R Offset / G Offset / B Offset	0-511
	Reset Temperature Tuning		
	Advanced Color Temperature Tuning	5% / 10% / 20% / 30% / 40% / 50% / 60% / 70% / 80% / 90% / 100%	R / G / B
Color Management	R / G / B / C / M / Y	Tint / Saturation / Gain	
	W Reset	R Gain / G Gain / B Gain	

Advanced Color Settings (Continued)	CinemaMaster	Color Enhancement	0–18
		Flesh Tone Optimization	-5–5
		Pixel Enhancer 4K	0–20
		Motion Enhancer 4K	Off / Low / Middle / High
		Local Contrast Enhancer	Off / Low / Middle / High
		Global Contrast Enhancer	Off / Low / Middle / High
	Dynamic Black	Off / On	
	Light Source Mode	Normal / ECO / Custom	
	Custom Brightness	50%–100%	
	HDR Brightness	-2 / -1 / 0 / 1 / 2	
Noise Reduction	Off / Low / Middle / High		
Reset Current Picture Mode		Reset / Cancel	

Function descriptions

Menu	Descriptions
Picture Mode	<p>The projector is preset with several predefined picture modes so that you can choose one to suit your operating environment and input signal picture type.</p> <ul style="list-style-type: none"> • Bright <p>Maximizes the brightness of the projected image. This mode is suitable for environments where extra-high brightness is required, such as using the projector in well lit rooms.</p> <ul style="list-style-type: none"> • Bright Cinema <p>Complement with accurate color and deepest contrast at higher brightness level, Bright Cinema mode is suitable for playing movies in an environment with a small amount of ambient light, e.g. your living room.</p> <ul style="list-style-type: none"> • Cinema <p>This mode is best for watching movies with accurate color and deepest contrast at lower brightness level in rooms with a bit of ambient light, as if in a commercial cinema.</p> <ul style="list-style-type: none"> • FILMMAKER MODE <p>This mode is best for watching movies with accurate color and deepest contrast at lower brightness level in rooms with a bit of ambient light, as if in a commercial cinema.</p> <ul style="list-style-type: none"> • 3D <p>Optimized to bring up 3D effects when watching 3D contents.</p>
	 <p>This mode is only available when 3D function is enabled.</p>

Picture Mode (Continued)

• HDR10/FILMMAKER MODE

Delivers High Dynamic Range effects with higher contrasts of brightness and colors for HDR Blu-ray movies. After auto-detecting metadata or EOTF info from HDR10 contents, **HDR10/FILMMAKER MODE** is available for selection.

• HDR10+

Delivers High Dynamic Range effects with higher contrasts of brightness and colors for HDR Blu-ray movies. This mode is only available when HDR10+ content is detected. When **HDR10+** is selected, **HDR Brightness** will be grayed out.

• HLG

Delivers High Dynamic Range effects with higher contrasts of brightness and colors. **Picture Mode** will be switched to **HLG** automatically while detecting metadata or EOTF info from HLG streaming contents.

• User

Recalls the settings customized based on the current available picture modes. Refer to "[User Management](#)" on page 32.

There is one user-definable mode if the current available picture modes are not suitable for your need. You can use one of the picture modes (except **User**) as a starting point and customize the settings.

• Load Settings From

1. Go to **Picture > Picture Mode**.
2. Press **◀/▶** to select **User**.
3. Press **▼** to select **User Management**, then press **OK**. The **User Management** page is displayed.
4. Select **Load Settings From** and press **OK**.
5. Press **▼/▲** to select a picture mode that is closest to your need.
6. Press **OK** and **BACK** to return to the **Picture** menu.
7. Press **▼** to select the submenu item you want to change, and use **◀/▶** to adjust the value. The adjustments define the selected user mode.

User Management

• Rename User Mode

Select to rename the customized picture modes (**User**). The new name can be up to 9 characters including English letters (A-Z, a-z), digits (0-9), and space (_).

1. Go to **Picture > Picture Mode**.
 2. Press **◀/▶** to select **User**.
 3. Press **▼** to select **User Management**, then press **OK**. The **User Management** page is displayed.
 4. Press **▼** to select **Rename User Mode**, then press **OK**. The **Rename User Mode** page is displayed.
 5. Use **▲/▶/▼/◀** and **OK** to choose the characters you want.
 6. When done, press **BACK** to save the changes and exit.
-

Brightness	The higher the value, the brighter the image. Adjust this control so the black areas of the image appear just as black and that detail in the dark areas is visible.
Contrast	The higher the value, the greater the contrast. Use this to set the peak white level after you have previously adjusted the Brightness setting to suit your selected input and viewing environment.
Color	Adjusts the color saturation level - the amount of each color in a video picture. Lower settings produce less saturated colors; setting to the minimum value makes the image black and white. If the setting is too high, colors on the image will be overpowering, which makes the image unrealistic.
Tint	Adjusts the red and green color tones of the image. The higher the value, the more greenish the picture becomes. The lower the value, the more reddish the picture becomes.
Sharpness	Adjust the picture to look sharper or softer. The higher the value, the sharper the picture becomes.
EXTREME COLOR	Adjust the picture to look saturated or softer. The higher the value, the brighter the picture becomes.

• Gamma Selection

Gamma refers to the relationship between input source and picture brightness.

- **1.8/2.0/2.1/BenQ**: Select these values according to your preference.
- **2.2/2.3**: Increases the average brightness of the picture. Best for a lit environment, meeting room or family room.
- **2.4/2.5**: Best for viewing movies in a dark environment.
- **2.6**: Best for viewing movies which are mostly composed of dark scenes.

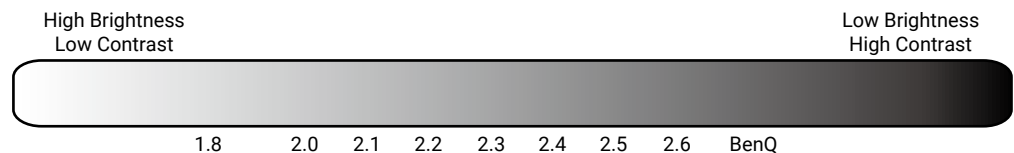

• Color Temperature Tuning

There are several preset color temperature settings available. The available settings may vary according to the signal type selected.

When **Bright** is selected for **Picture Mode**, the color temperature switches to **Native**, and cannot be changed.

- **Native**: With the light source's original color temperature and higher brightness, this setting is suitable for environments where high brightness is required, such as projecting pictures in well lit rooms.
- **Normal**: Maintains normal colorings for white.
- **Cool**: Makes images appear bluish white.
- **Warm**: Makes images appear reddish white.

You can also set a preferred color temperature by adjusting the following options.

- **R Gain/G Gain/B Gain**: Adjusts the contrast levels of Red, Green, and Blue.
- **R Offset/G Offset/B Offset**: Adjusts the brightness levels of Red, Green, and Blue.

• Advanced Color Temperature Tuning

Used for fine-tuning **White Balance** from the bright part to the dark part of the video by different brightness levels. These levels are divided into 11 points according to each signal level (%). You can adjust the intensity of Red/Green/Blue in the range of 0~100 for the color temperature of selected point at different brightness level. Selecting **Reset** returns all settings in this menu to the factory preset values.

Advanced Color Settings

• Color Management

The Color Management provides six sets (RGBCMY) of colors to be adjusted. When you select each color, you can independently adjust its range and saturation according to your preference.

To make adjustments, press the ▲/▼ arrows to highlight an independent color from among Red (R), Green (G), Blue (B), Cyan (C), Magenta (M), or Yellow (Y), and press **OK**. The following menu items are displayed for your choice.

- **Tint:** Increase in the range will include colors consisted of more proportions of its two adjacent colors. Please refer to the illustration for how the colors relate to each other.

For example, if you select Red and set its range at 0, only pure red in the projected picture will be selected. Increasing its range will include both the red color close to yellow and red color close to magenta.

- **Saturation:** Adjusts the values to your preference. Every adjustment made will reflect to the image immediately. For example, if you select Red and set its value at 0, only the saturation of pure red will be affected.
- **Gain:** Adjusts the values to your preference. The contrast level of the primary color you select will be affected. Every adjustment made will reflect to the image immediately.

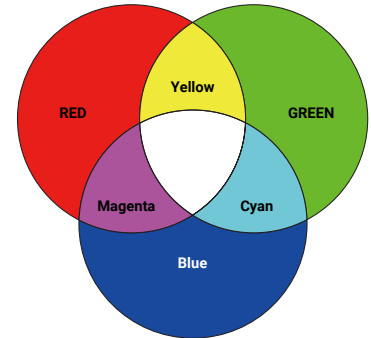

Advanced Color Settings (continued)

If you selected **White Balance (W)**, you can adjust the contrast levels of Red, Green, and Blue by selecting **R Gain**, **G Gain**, and **B Gain**.

To return all the settings to the factory default values, highlight **Reset**, and press **OK**.



Saturation is the amount of that color in a video picture. Lower settings produce less saturated colors; a setting of "0" removes that color from the image entirely. If the saturation is too high, that color will be overpowering and unrealistic.

• Wide Color Gamut

Color Gamut refers to the range of colors that can potentially be displayed by a device. There are some standards to define difference levels of color gamuts for display devices, such as CIE 1976, sRGB, Adobe RGB, NTSC, etc. Select **On** to enable the color filter module to extend its color gamut to DCI-P3.

This function is only selectable when **HDR10** or **HLG** is selected. With this projector, selecting **On** will automatically apply the most suitable color gamut to the image source.

**Advanced Color
Settings
(continued)**

- **CinemaMaster**

- **Color Enhancer:** Allows you to fine-tune the saturation of colors with larger flexibility. It modulates complex color algorithms to flawlessly render saturated colors, fine gradients, intermediate hues and subtle pigments.
- **Flesh Tone:** Provides a smart adjustment of hue only for calibrating people's skin color, not other colors in the image. It prevents discoloration of skin tones from the light of the projection beam, portraying every skin tone in its most beautiful shade.
- **Pixel Enhancer 4K:** It is a super-resolution technology which radically enhances Full HD content in terms of colors, contrast, and textures. It's also a Detail Enhancement Technology refining surface details for true-to-life images that pop off the screen. Users can adjust levels of sharpness and detail enhancement for optimal viewing.
- **Motion Enhancer 4K:** To enhance picture smoothness by motion estimation/motion compensation.
- **Local Contrast Enhancer:** Divides video content into different "zones" and dims the dark parts of the screen without affecting the bright areas. This makes the contrast look great for watching movies, especially in a dark environment.
- **Global Contrast Enhancer:** Adjusts frame content of the brightness of the picture. This makes the contrast look great for watching movies, especially in a dark environment.

- **Dynamic Black**

Adjusts frame content of the brightness of the picture to improve the contrast between video scenes.

- **Light Source Mode**

Selects a suitable light power from among the provided modes. Refer to ["Extending light source life" on page 49](#).

- **Custom Brightness**

Adjusts the light power manually. This mode is only available when the **Light Source Mode** is set at **Custom**.

- **HDR Brightness**

The projector can automatically adjust the brightness levels of your image according to the input source. You can also manually select a brightness level to display better picture quality. When the value is higher, the image becomes brighter; when the value is lower, the image becomes darker.

- **Noise Reduction**

Reduces electrical image noise caused by different media players.

Reset Current Picture Mode

Returns all of the adjustments you've made for the selected **Picture Mode** (including the preset mode, **User**) to the factory preset values.

1. Press **OK**. The confirmation message is displayed.
2. Use ◀/▶, select **Reset**, and then press **OK**. The current picture mode returns to the factory preset settings.





The following settings will still remain: **Picture Mode, User Management**.

2. Main menu: **Display**

Structure

Menu		Options	
Aspect Ratio		Auto / 4:3 / 16:9 / 2.35:1	
3D	3D Mode	Auto / Frame Sequential / Frame Packing / Top Bottom / Side by Side / Off	
	3D Sync Invert	Disable / Invert	
3D Sync Signal Output		Off / On	
HDMI Settings	HDMI Format	Auto / Limited / Full	
	HDMI EDID	HDMI-1	Enhanced / Standard
		HDMI-2	Enhanced / Standard
	HDMI Device Control	Off / On	
	HDMI Power On/Off Link	Off / On	
Source Rename	HDMI-1 / HDMI-2		
Reset Display		Reset / Cancel	

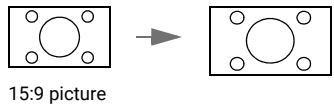
Function descriptions

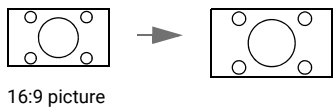
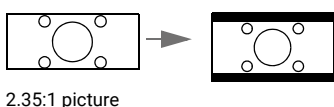
Menu	Descriptions
Aspect Ratio	<p>There are several options to set the image's aspect ratio depending on your input signal source.</p> <ul style="list-style-type: none"> • Auto Scales a picture proportionally to fit the projector's native resolution in its horizontal or vertical width. • 4:3 Scales an image so that it is displayed in the center of the screen with a 4:3 aspect ratio. • 16:9 Scales an image so that it is displayed in the center of the screen with a 16:9 aspect ratio. • 2.35:1 Scales an image so that it is displayed in the center of the screen with a 2.35:1 aspect ratio.
	 <p>15:9 picture</p>
	 <p>4:3 picture</p>
	 <p>16:9 picture</p>
	 <p>2.35:1 picture</p>

This projector supports playing three-dimensional (3D) content transferred through your 3D-compatible video devices and contents, such as PlayStation consoles (with 3D game discs), 3D Blu-ray players (with 3D Blu-ray discs), and so on. After you have connected the 3D video devices to the projector, wear the BenQ 3D glasses and make sure the power is on to view 3D contents.

When watching 3D contents:

- The image may seem misplaced; however, this is not a product malfunction.
- Take appropriate breaks when watching 3D contents.
- Stop watching 3D content if you feel fatigue or discomfort.
- Keep a distance from the screen of about three times the effective height of the screen.
- Children and people with a history of oversensitivity to light, heart problems, or any other existing medical conditions should be refrained from watching 3D contents.
- The image may seem reddish, greenish, or bluish without wearing 3D glasses. However, you will not notice any color bias when watching 3D contents with 3D glasses.
- The 4K source will not be displayed.

• **3D Mode**

The default setting is **Auto** and the projector automatically chooses an appropriate 3D format when detecting 3D contents. If the projector cannot recognize the 3D format, you can choose **Frame Sequential**, **Frame Packing**, **Top Bottom** or **Side by Side** for it.

When this function is enabled:

- The brightness level of the projected image decreases.
- The **Picture Mode** cannot be adjusted.
- The **2D Keystone** can only be adjusted within limited degrees.

• **3D Sync Invert**

When your 3D image is distorted, enable this function to switch between the image for the left eye and the right eye for more comfortable 3D viewing experience.

3D

3D Sync Signal Output

When this function is enabled, the 3D Sync Signal Transmitter needs to be connected to the 3D SYNC OUT terminal to view 3D movies in IR 3D.

When this function is disabled, 3D glasses can be connected via DLP Link.

- **HDMI Format**

Selects a suitable RGB color range to correct the color accuracy.

- **Auto:** Automatically selects a suitable color range for the incoming HDMI signal.
- **Limited:** Utilizes the Limited range RGB 16-235.
- **Full:** Utilizes the Full range RGB 0-255.

- **HDMI EDID**

Switches between **Enhanced** for HDMI 2.0 EDID and **Standard** for HDMI 1.4 EDID. Selecting **Standard** which supports up to 1080p 60Hz may solve abnormal display issues with some old players.

- **HDMI Device Control**

When you enable this function and connect an HDMI CEC-compatible device to your projector with an HDMI cable, turning on the HDMI CEC compatible device automatically turns on the projector, while turning off the projector automatically turns off the HDMI CEC compatible device.

- **HDMI Power On/Off Link**

When you connect an HDMI CEC-compatible device to your projector with an HDMI cable, you can set the behavior of powering on/off between the device and the projector.

HDMI Power On/Off Link > On	When the connected device is turned on, the projector will be activated, too.
	When the projector is turned off, the connected device will be shut down, too.

- **Source Rename**

Renames the current input source to your desired name.

On the **Source Rename** page:

1. Press **OK** to display the on-screen keyboard.
2. Press **▲/▼/◀/▶** to select the desired number/letter, then press **OK** to confirm entry.
3. Repeat the step above and when done, press **Submit**.
4. Press **OK** and the source name changes.

HDMI Settings

Reset Display

Returns all the settings on the **Display** main menu to the factory default values.

3. Main menu: **Audio**

Structure

Menu	Options
Audio Output	S/PDIF / Audio Return+
Audio Output Format	LPCM / RAW
Reset Audio	Reset / Cancel

Function descriptions

Menu	Descriptions
Audio Output	<p>To enjoy S/PDIF digital sound effect, make sure the SPDIF connector on the projector is connecting to a compatible audio system.</p> <p>To enjoy Audio Return+ sound effect, make sure to turn on the eARC/ARC function from your soundbar as well.</p> <p>Audio Return+ supports multi-audio outputs including 2.0, 5.1, and 7.1 to external audio systems like soundbars.</p>
Audio Output Format	<p>The following audio output formats are provided to achieve the audio performance you desire: LPCM supports 2 channel audio output, RAW supports 5.1 channel audio output.</p>
Reset Audio	<p>Returns all of the adjustments you've done under the Audio menu to the factory preset values.</p>

4. Main menu: **Installation**

Structure

Menu		Options	
Projector Position		Front / Front Ceiling / Rear / Rear Ceiling	
Lens Control	Lens Lock	Off / On	
	Focus & Zoom		
	Lens Shift		
2D Keystone		H: -35 – +35 V: -35 – +35	
Test Pattern		Off / On	
High Altitude Mode		Off / On	
Network Settings	Serial Port Setting	Port Selection	RS232 / LAN
		Baud Rate	9600 / 19200 / 38400 / 57600 / 115200
		Status	Connect / Disconnect
	Wired LAN	DHCP	Off / On
		IP Address	0.0.0.0
		Subnet Mask	0.0.0.0
		Default Gateway	0.0.0.0
		DNS Server	0.0.0.0
		Apply	
		Control4	Off / On
	MAC Address (Wired)		
	Network Standby Settings	Enable Network Standby Mode	Off / On
		Auto Disable Network Standby Mode	Never / 20 Min / 1 H / 3 H / 6 H

Function descriptions

Menu	Descriptions
Projector Position	The projector can be installed on a ceiling or behind a screen, or with one or more mirrors. See " Choosing a location " on page 14 for details.
Lens Control	<ul style="list-style-type: none"> • Lens Lock <p>When this function is enabled, the Focus & Zoom, and Lens Shift functions is grayed out to prevent incorrect adjustments.</p>
	<ul style="list-style-type: none"> • Focus & Zoom • Lens Shift <p>Adjust the image clarity and projected image size electrically with the arrow keys.</p> <ul style="list-style-type: none"> • Adjust the image position of the projector electrically with the arrow keys.

See "[Correcting keystone](#)" on page 20 for details.

2D Keystone

This image adjustment might impact latency in **Game Mode**. We suggest setting the **2D Keystone** values to 0 to enjoy low latency gaming.

Adjusts the image size and focus and check that the projected image is free from distortion.

Test Pattern

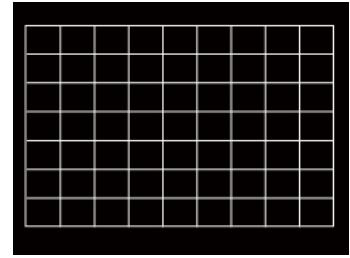

We recommend you to use the **High Altitude Mode** when your environment is between 1500 m - 2000 m above sea level, and ambient temperature is between 0°C to 30°C.

Operation under "**High Altitude Mode**" may cause a higher decibel operating noise level because of increased fan speed necessary to improve overall system cooling and performance.

High Altitude Mode

If you use this projector under other extreme conditions excluding the above, it may display auto shut-down symptoms, which is designed to protect your projector from over-heating. In cases like this, you should switch to High Altitude mode to solve these symptoms. However, this is not to state that this projector can operate under any and all harsh or extreme conditions.



Do not use the **High Altitude Mode** if your altitude is between 0 m to 1500 m and ambient temperature is between 0°C to 35°C. The projector will be over cooled, if you turn the mode on under such a condition.

- **Serial Port Setting**

- **Port Selection:** Selects a port depends on your need.
- **Baud Rate:** Selects a baud rate that is identical with your computer's so that you can connect the projector with a suitable RS-232 cable and update or download the projector's firmware. This function is intended for qualified service personnel.

- **Control4**

If you wish to use the projector through a home automation system, and has connected the projector to the network, select **On**.

- **MAC Address (Wired)**

Displays the Media Access Control Address.

Network Settings

- **Network Standby Settings**

This menu provides basic and advanced settings for network control when the projector is in standby mode.

- **Enable Network Standby Mode:** Selecting **On** will keep the projector at a lower power consumption than it is on while the projector is available for network control. If selecting **Off**, the projector disconnects from network.
 - **Auto Disable Network Standby Mode:** If **Enable Network Standby Mode** is set at **On**, you can decide a time period in this menu to disable the network standby function when there is no network activity occurs. Selecting **20 Min/1 H/3 H/6 H** sets the projector to switch to non-network standby status after that period of time. Selecting **Never** will always keep the projector connected for network control.
-



5. Main menu: **System**

Structure

Menu	Options	
Language	English / 简体中文 / 繁體中文	
Background Settings	Splash Screen	BenQ / Black / Blue
Menu Settings	Menu Type	Basic / Advanced
	Menu Display Time	5 Sec / 10 Sec / 20 Sec / 30 Sec / Always
	Menu Position	Center / Top-Left / Top-Right / Bottom-Right / Bottom-Left
	ISF	(Input Password)
Color Calibration	Auto Color Calibration	Off / On
Light Source Information	Light Source Usage Time	
	Normal mode	
	Economic Mode	
Operation Settings	Custom Mode	
	Reminder Message	Off / On
	LED Indicator	Off / On
	Direct Power On	Off / On
	Power On/Off Settings	Auto Power Off
Firmware Upgrade	Yes / No	
Factory Default	Reset / Cancel	
Reset System	Reset / Cancel	

Function descriptions

Menu	Descriptions
Language	Sets the language for the On-Screen Display (OSD) menus.
Background Settings	• Splash Screen
	Allows you to select which logo screen will be displayed during projector start-up.

	<ul style="list-style-type: none"> • Menu Type Sets the OSD menu type according to your needs. • Menu Display Time Sets the length of time the OSD will remain active after your last key press. • Menu Position Sets the On-Screen Display (OSD) menu position. • ISF The ISF calibration menu is password protected and only accessible by authorized ISF calibrators. The ISF (Imaging Science Foundation) has developed carefully crafted, industry-recognized standards for optimal video performance and has implemented a training program for technicians and installers to use these standards to obtain optimal picture quality from BenQ video display devices. Accordingly, we recommend that setup and calibration be performed by an ISF certified installation technician.  <p>For more information, go to www.imagingscience.com or contact the dealer or retailer from whom you purchased the projector.</p>
Light Source Information	<p>This menu page displays the following information:</p> <ul style="list-style-type: none"> • Light Source Usage Time • Light used under Normal mode, Economic Mode and Custom Mode.
Operation Settings	<ul style="list-style-type: none"> • Reminder Message Sets the reminder messages on or off. • LED Indicator You can turn off the LED warning lights. This is to avoid any light disturbance when viewing images in a dark room. • Power On/Off Settings <ul style="list-style-type: none"> • Direct Power On: Allows the projector to turn on automatically once the power is fed through the power cord. • Auto Power Off: Allows the projector to turn off automatically if no input signal is detected after a set period of time to prevent unnecessary waste of light source life.
Firmware Upgrade	<p>Upgrades the firmware. Refer to "Upgrades the firmware" on page 27.</p>
Factory Default	<p>Returns all settings to the factory preset values.</p>  <p>The following settings will remain: Projector Position, 2D Keystone, High Altitude Mode, Network Settings, Light Source Information.</p>
Reset System	<p>Returns all the settings on the System main menu to the factory default values.</p>  <p>The following settings will still remain: Light Source Information.</p>

6. Main menu: **Information**

Function descriptions

Menu	Descriptions
Detected Resolution	Shows the native resolution of the input signal.
Source	Shows the current signal source.
Picture Mode	Shows the selected mode on the Picture menu.
Light Source Mode	Shows the used light source mode.
	Shows the current 3D mode.
3D Format	 3D Format is only available when 3D is enabled.
Color System	Shows the input system format.
Dynamic Range	Shows the picture dynamic range, e.g. SDR, HDR10, HLG, etc.
Light Source Usage Time	Shows the number of hours the light has been used.
Firmware Version	Displays the firmware version of your projector.
Service Code	Shows the service code of your projector.

Maintenance

Care of the projector

Cleaning the lens

Clean the lens whenever you notice dirt or dust on the surface. Be sure to turn off the projector and let it cool down completely before cleaning the lens.

- Use a canister of compressed air to remove dust.
- If there is dirt or smears, use lens-cleaning paper or moisten a soft cloth with lens cleaner and gently wipe the lens surface.
- Never use any type of abrasive pad, alkaline/acid cleaner, scouring powder, or volatile solvent, such as alcohol, benzene, thinner or insecticide. Using such materials or maintaining prolonged contact with rubber or vinyl materials may result in damage to the projector surface and cabinet material.

Please note that it is normal to have some dust on the lens surface. If it needs lens clean, please never remove any parts of the projector.

Contact your dealer or local customer service center if the projector fails to operate as expected.

Cleaning the projector case

Before you clean the case, turn the projector off using the proper shutdown procedure as described in "[Shutting down the projector](#)" on page 28 and unplug the power cord.

- To remove dirt or dust, wipe the case with a soft, lint-free cloth.
- To remove stubborn dirt or stains, moisten a soft cloth with water and a neutral pH detergent. Then wipe the case.



Never use wax, alcohol, benzene, thinner or other chemical detergents. These can damage the case.

Storing the projector

If you need to store the projector for an extended time, please follow the instructions below:

- Make sure the temperature and humidity of the storage area are within the recommended range for the projector. Please refer to "[Specification](#)" on page 53 or consult your dealer about the range.
- Retract the adjuster feet.
- Remove the battery from the remote control.
- Pack the projector in its original packing or equivalent.

Transporting the projector

It is recommended that you ship the projector with its original packing or equivalent.

Light Source Information

Getting to know the light source hour

When the projector is in operation, the duration (in hours) of light source usage is automatically calculated by the built-in timer. The method of calculating is as follows:

Light Usage Time = (x+y+a) hours, if

Time used in the **Normal** mode = x hours

Time used in the **ECO** mode = y hours

Time used in the **Custom** mode = a hours



For time used in each light source mode shown in OSD menu:

- Time used is accumulated and rounded down to an integer in **hours**.
- When time used is less than 1 hour, it shows 0 hours.

To obtain the light source information:

Go to **Advanced Menu - System > Light Source Information**, then press **OK**. The **Light Source Information** page is displayed.

You can also get the light hour information on the **Information** menu.

Extending light source life

- Setting **Light Source Mode**

Go to **Advanced Menu - Picture > Advanced Color Settings > Light Source Mode** and press **◀/▶** to select a suitable light source power from among the provided modes.

Setting the projector in **ECO**, or **Custom** mode extends light life.

Light Source Mode	Descriptions
Normal	Provides full light brightness.
ECO	Lowers brightness to extend the light source life and decreases the fan noise.
Custom	Adjusts the light power manually from 50% to 100% in 1% increments.

- Setting **Auto Power Off**































































This function allows the projector to turn off automatically if no input signal is detected after a set period of time to prevent unnecessary waste of light source life.

































To set **Auto Power Off**, go to **Advanced Menu - System > Operation Settings > Power On/Off Settings > Auto Power Off** and press **◀/▶** to set the time period.











The light source (LED) can last around 20,000-30,000 hours and no need to be changed during the lifetime of the projector mostly. When it is needed, light source replacement is not user-serviceable. Please contact the service center for assistance.

Indicator

POWER	TEMP	LIGHT	Status & Description
System Information			
			Stand-by mode
			Powering up
			Normal operation
			Normal power-down cooling
			Download
			Color wheel start failure
			MT9669 shutdown failed
			MT9669 and GD32 communication timed out
			MT9669 and GD32 communication error
			MT9669 and ES858 communication timed out
			MT9669 and ES858 communication error
Light Source Information			
			Light is not lit up
			Light source EEPROM initialization failed
Thermal information			
			Fan 1 error (the actual fan speed is outside the desired speed)
			Fan 2 error (the actual fan speed is outside the desired speed)
			Fan 3 error (the actual fan speed is outside the desired speed)
			Fan 4 error (the actual fan speed is outside the desired speed)
			Fan 5 error (the actual fan speed is outside the desired speed)
			Temperature 1 error (over limited ambient temperature)
			Thermal Sensor 1 open error
			Thermal Sensor 1 short error

			Temperature 2 error (over limited power supply temperature)
			Temperature 3 error (over limited DMD temperature)
			DMD thermal sensor failed to initialize
			Temperature 4 error (over limited color wheel motor axis temperature)
			Thermal Sensor 4 open error
			Thermal Sensor 4 short error
			Temperature 5 error (over limited LD temperature)
			Thermal Sensor 5 open error
			Thermal Sensor 5 short error
			The temperature of the laser light source 1 does not match
			The temperature of the laser light source 2 does not match

  : Off
  : Orange on
 : Green On
 : Red On

 : Orange Flashing
 : Green Flashing
 : Red Flashing

Troubleshooting

? The projector does not turn on.

Cause	Remedy
There is no power from the power cord.	Plug the power cord into the AC power jack on the projector, and plug the power cord into the power outlet. If the power outlet has a switch, make sure that it is switched on.
Attempting to turn the projector on again during the cooling process.	Wait until the cooling down process has completed.

? No picture

Cause	Remedy
The video source is not turned on or connected correctly.	Turn the video source on and check that the signal cable is connected correctly.
The projector is not correctly connected to the input signal device.	Check the connection.
The input signal has not been correctly selected.	Select the correct input signal with the SOURCE key.

? Blurred image

Cause	Remedy
The projection lens is not correctly focused.	Adjust the focus of the lens using the focus ring.
The projector and the screen are not aligned properly.	Adjust the projection angle and direction as well as the height of the projector if necessary.

? Remote control does not work.

Cause	Remedy
The batteries are out of power.	Replace both of the batteries with new ones.
There is an obstacle between the remote control and the projector.	Remove the obstacle.
You are too far away from the projector.	Stand within 8 meters (26 feet) of the projector.

Specification

Projector specifications



All specifications are subject to change without notice.

Optical

Resolution

3840 x 2160

Display system

1-CHIP DMD

Lens

F = 2.1 to 3.0, f = 16.0 to 25.7 mm

Clear focus range

60" - 200"

Light source

Laser

Electrical

Power supply

AC 100 - 240V, 50 - 60 Hz (Automatic)

Power consumption

460 W (Max); < 0.5 W (Standby)

Mechanical

Weight

10.5 Kg \pm 200 g (23.15 \pm 0.44 lbs)

Output terminals

Audio signal output

S/PDIF x 1

HDMI-1 eARC/ARC

3D Sync Out x 1

Input terminals

Digital

- HDMI-1 (2.1, HDCP 2.2, CEC/ARC/eARC with multichannel audio output)

- HDMI-2 (2.1, HDCP 2.2)

Control

RS-232 serial control

9 pin x 1

IR receiver x 2

LAN RJ-45 LAN x 1

USB

- USB-1 (Type A 2.0, 5V 2.0A): USB reader

- USB-2 (Type A 2.0, 5V 1.5A): USB reader, USB charging only for projector power on status, FW update

- SERVICE (Type B): for system update

Environmental Requirements

Operating temperature

0°C - 40°C at sea level (Normal mode > 35°C @ Eco light source power)

Storage temperature

-20°C - 60°C at sea level

Operating/Storage relative humidity

10% - 90% (without condensation)

Operating altitude

0 - 1499 m at 0°C - 35°C (Normal mode > 35°C @ Eco light source power)

1500 - 3000 m at 0°C - 30°C (Normal mode > 35°C @ Eco light source power) (with High Altitude Mode on)

Storage altitude

30°C @ 0 - 12,200 m above sea level

Repairing

Please visit below website and choose your country to find your service contact window.

<http://www.benq.com/welcome>

Transporting

Original packing or equivalent is recommended.

Dimensions

Projector dimensions

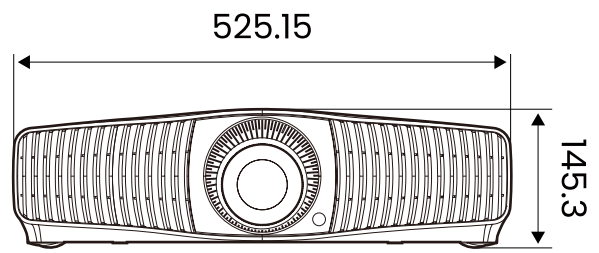
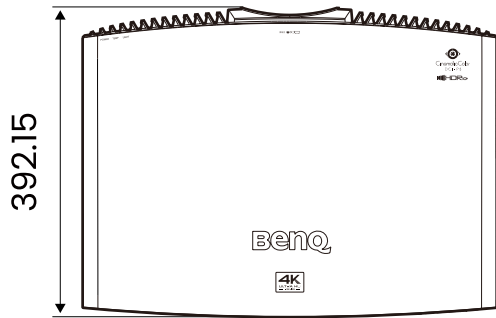

Unit: mm

Timing chart

Supported timing for HDMI (HDCP) input

- PC timings

Resolution	MODE	Refresh Rate (Hz)	Horizontal Frequency (kHz)	Clock (MHz)	Supported 3D format		
					Frame Sequential	Top Bottom	Side by Side
640 x 480	VGA_60	59.940	31.469	25.175		V	V
	VGA_72	72.809	37.861	31.500			
	VGA_75	75.000	37.500	31.500			
	VGA_85	85.008	43.269	36.000			
800 x 600	SVGA_60	60.317	37.879	40.000		V	V
	SVGA_72	72.188	48.077	50.000			
	SVGA_75	75.000	46.875	49.500			
	SVGA_85	85.061	53.674	56.250			
1024 x 768	XGA_60	60.004	48.363	65.000		V	V
	XGA_70	70.069	56.476	75.000			
	XGA_75	75.029	60.023	78.750			
	XGA_85	84.997	68.667	94.500			
1280 x 720	1280 x 720_60	60	45.000	74.250		▲	▲
	1280 x 720_120	120	90.000	148.500		V	V
1280 x 768	1280 x 768_60 (Reduce Blanking)	60	47.396	68.25		V	V
	1280 x 768_60	59.870	47.776	79.5		V	V
1280 x 800	WXGA_60	59.810	49.702	83.500		V	V
	WXGA_75	74.934	62.795	106.500			
	WXGA_85	84.880	71.554	122.500			
1280 x 1024	SXGA_60	60.020	63.981	108.000			
	SXGA_75	75.025	79.976	135.000			
	SXGA_85	85.024	91.146	157.500			
1280 x 960	1280 x 960_60	60.000	60.000	108		V	V
	1280 x 960_85	85.002	85.938	148.500			
1360 x 768	1360 x 768_60	60.015	47.712	85.500		V	V
	WXGA+_60	59.887	55.935	106.500			
1400 x 1050	SXGA+_60	59.978	65.317	121.750		V	V
1600 x 1200	UXGA	60.000	75.000	162.000		V	
1920 x 1080@60 HZ	1920 x 1080_60 (CEA-861)	60	67.5	148.5	V	▲	▲
1920 x 1200@60 HZ	1920 x 1200_60 (Reduce Blanking)	59.95	74.038	154			
1920 x 1080@120 HZ	1920 x 1080_120	120.000	135.000	297			
3840 x 2160	3840 x 2160_30 For 4K2K model	30	67.5	297			
3840 x 2160	3840 x 2160_60 For 4K2K model	60	135	594			

• Video timings

Timing	Resolu- tion	Horizontal Frequency (KHz)	Vertical Frequency (Hz)	Dot Clock Frequency (MHz)	Supported 3D format			
					Frame Sequen- tial	Frame Pack- ing	Top Bottom	Side by Side
576p	720 x 576	31.25	50	27				
720/50p	1280 x 720	37.5	50	74.25		▲	▲	
720/60p	1280 x 720	45.00	60	74.25	V	▲	▲	▲
1080/24P	1920 x 1080	27	24	74.25	V	▲	▲	▲
1080/25P	1920 x 1080	28.13	25	74.25	V	▲	▲	▲
1080/30P	1920 x 1080	33.75	30	74.25	V	▲	▲	▲
1080/50i	1920 x 1080	28.13	50	74.25				
1080/60i	1920 x 1080	33.75	60	74.25		▲	▲	▲
1080/50P	1920 x 1080	56.25	50	148.5		▲	▲	▲
1080/60P	1920 x 1080	67.5	60	148.5	V	▲	▲	▲
1080/120p	1920 x 1080	135	120	297				
2160/24P	3840 x 2160	54	24	297				
2160/25P	3840 x 2160	56.25	25	297				
2160/30P	3840 x 2160	67.5	30	297				
2160/50P	3840 x 2160	112.5	50	594				
2160/60P	3840 x 2160	135	60	594				



- ▲: Supports auto-detecting and manually setting 3D format.
- V: Supports manually setting 3D format.
- The timings showing above may not be supported due to EDID file and VGA graphic card limitations. It is possible that some timings cannot be chosen.

RS232 command

RS232 pin assignment

No.	Serial	No.	Serial
1	NC	6	NC
2	RX	7	RTSZ
3	TX	8	CTSZ
4	NC	9	NC
5	GND		

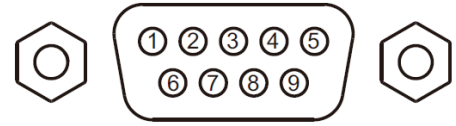

Function	Type	Operation	ASCII
Power	Write	Power On	<CR>*pow=on#<CR>
	Write	Power Off	<CR>*pow=off#<CR>
	Read	Power Status	<CR>*pow=?#<CR>
	Write	HDMI1	<CR>*sour=hdmi#<CR>
	Write	HDMI 2	<CR>*sour=hdmi2#<CR>
	Write	USB Reader	<CR>*sour=usbreader#<CR>
	Read	Current source	<CR>*sour=?#<CR>
Picture Mode	Write	Bright	<CR>*appmod=bright#<CR>
	Write	Bright Cinema	<CR>*appmod=brightcine#<CR>
	Write	FILMMAKER MODE	<CR>*appmod=filmmaker#<CR>
	Write	Cinema(Rec.709)	<CR>*appmod=cine#<CR>
	Write	User	<CR>*appmod=user#<CR>
	Write	ISF Day	<CR>*appmod=isfday#<CR>
	Write	ISF Night	<CR>*appmod=isfnight#<CR>
	Write	3D	<CR>*appmod=threed#<CR>
	Write	HDR10	<CR>*appmod=hdr#<CR>
	Write	HDR10+	<CR>*appmod=hdr+#<CR>
	Write	HLG	<CR>*appmod=hlg#<CR>
	Read	Picture Mode	<CR>*appmod=?#<CR>
Picture Setting	Write	Contrast +	<CR>*con=+#<CR>
	Write	Contrast -	<CR>*con=-#<CR>
	Write	Set Contrast value	<CR>*con=value#<CR>
	Read	Contrast value	<CR>*con=?#<CR>
	Write	Brightness +	<CR>*bri=+#<CR>
	Write	Brightness -	<CR>*bri=-#<CR>

Function	Type	Operation	ASCII
Picture Setting (continued)	Write	Set Brightness value	<CR>*bri=value#<CR>
	Read	Brightness value	<CR>*bri=?#<CR>
	Write	Color +	<CR>*color=+#<CR>
	Write	Color -	<CR>*color=-#<CR>
	Write	Set Color value	<CR>*color=value#<CR>
	Read	Color value	<CR>*color=?#<CR>
	Write	Sharpness +	<CR>*sharp=+#<CR>
	Write	Sharpness -	<CR>*sharp=-#<CR>
	Write	Set Sharpness value	<CR>*sharp=value#<CR>
	Read	Sharpness value	<CR>*sharp=?#<CR>
	Write	Flesh Tone +	<CR>*fleshtone=+#<CR>
	Write	Flesh Tone -	<CR>*fleshtone=-#<CR>
	Write	Set Flesh Tone value	<CR>*fleshtone=value#<CR>
	Read	Flesh Tone value	<CR>*fleshtone=?#<CR>
	Write	Color Temperature-Warm	<CR>*ct=warm#<CR>
	Write	Color Temperature-Normal	<CR>*ct=normal#<CR>
	Write	Color Temperature-Cool	<CR>*ct=cool#<CR>
	Write	Color Temperature-lamp native	<CR>*ct=ative#<CR>
	Read	Color Temperature Status	<CR>*ct=?#<CR>
	Write	Aspect 4:3	<CR>*asp=4:3#<CR>
	Write	Aspect 16:9	<CR>*asp=16:9#<CR>
	Write	Aspect 2.35:1	<CR>*asp=2.35#<CR>
	Write	Aspect Auto	<CR>*asp=AUTO#<CR>
	Read	Aspect Status	<CR>*asp=?#<CR>
	Write	Vertical Keystone +	<CR>*vkeystone=+#<CR>
	Write	Vertical Keystone -	<CR>*vkeystone=-#<CR>
	Read	Vertical Keystone value	<CR>*vkeystone=?#<CR>
	Write	Horizontal Keystone +	<CR>*hkeystone=+#<CR>
	Write	Horizontal Keystone -	<CR>*hkeystone=-#<CR>
	Read	Horizontal Keystone value	<CR>*hkeystone=?#<CR>
	Write	Reset current picture settings	<CR>*rstcurpicsetting#<CR>
	Write	Reset all picture settings	<CR>*rstallpicsetting#<CR>

Function	Type	Operation	ASCII
Operation Settings	Write	Projector Position-Front Table	<CR>*pp=FT#<CR>
	Write	Projector Position-Rear Table	<CR>*pp=RE#<CR>
	Write	Projector Position-Rear Ceiling	<CR>*pp=RC#<CR>
	Write	Projector Position-Front Ceiling	<CR>*pp=FC#<CR>
	Read	Projector Position Status	<CR>*pp=?#<CR>
	Read	Quick auto search status	<CR>*QAS=?#<CR>
	Write	Menu Position - Center	<CR>*menuposition=center#<CR>
	Write	Menu Position - Top-Left	<CR>*menuposition=tl#<CR>
	Write	Menu Position - Top-Right	<CR>*menuposition=tr#<CR>
	Write	Menu Position - Bottom-Right	<CR>*menuposition=br#<CR>
	Write	Menu Position - Bottom-Left	<CR>*menuposition=bl#<CR>
	Read	Menu Position Status	<CR>*menuposition=?#<CR>
	Write	Direct Power On-on	<CR>*directpower=on#<CR>
	Write	Direct Power On-off	<CR>*directpower=off#<CR>
	Read	Direct Power On-Status	<CR>*directpower=?#<CR>
	Write	Standby Settings-Network on	<CR>*standbynet=on#<CR>
	Write	Standby Settings-Network off	<CR>*standbynet=off#<CR>
	Read	Standby Settings-Network Status	<CR>*standbynet=?#<CR>
Baud Rate	Write	9600	<CR>*baud=9600#<CR>
	Write	19200	<CR>*baud=19200#<CR>
	Write	38400	<CR>*baud=38400#<CR>
	Write	57600	<CR>*baud=57600#<CR>
	Write	115200	<CR>*baud=115200#<CR>
	Read	Current Baud Rate	<CR>*baud=?#<CR>
Lamp Control	Read	Lamp	<CR>*ltim=?#<CR>
	Write	Normal mode	<CR>*lampm=lnor#<CR>
	Write	Eco mode	<CR>*lampm=eco#<CR>
	Write	Dynamic Black	<CR>*appmod=dynamic#<CR>

Function	Type	Operation	ASCII
Lamp Control (continued)	Write	Custom mode	<CR>*lampm=custom#<CR>
	Write	Light level for custom mode	<CR>*lampcustom=value#<CR>
	Read	Light level status for custom mode	<CR>*lampcustom=?#<CR>
	Read	Lamp Mode Status	<CR>*lampm=?#<CR>
Miscellaneous	Read	Model Name	<CR>*modelname=?#<CR>
	Read	System F/W Version	<CR>*sysfwversion=?#<CR>
	Read	Scaler F/W Version	<CR>*scalerfwversion=?#<CR>
	Read	Lan F/W Version	<CR>*lanfwversion=?#<CR>
	Read	MCU F/W Version	<CR>*mcufwversion=?#<CR>
	Write	Blank On	<CR>*blank=on#<CR>
	Write	Blank Off	<CR>*blank=off#<CR>
	Read	Blank Status	<CR>*blank=?#<CR>
	Write	Menu On	<CR>*menu=on#<CR>
	Write	Menu Off	<CR>*menu=off#<CR>
	Read	Menu Status	<CR>*menu=?#<CR>
	Write	Up	<CR>*up#<CR>
	Write	Down	<CR>*down#<CR>
	Write	Right	<CR>*right#<CR>
	Write	Left	<CR>*left#<CR>
	Write	Enter	<CR>*enter#<CR>
	Write	Back	<CR>*back#<CR>
	Write	Source Menu On	<CR>*sourmenu=on#<CR>
	Write	Source Menu Off	<CR>*sourmenu=off#<CR>
	Read	Source Menu Status	<CR>*sourmenu=?#<CR>
	Write	3D Sync Off	<CR>*3d=off#<CR>
	Write	3D Sync On	<CR>*3d=on#<CR>
	Write	3D Auto	<CR>*3d=auto#<CR>
	Write	3D Sync Top Bottom	<CR>*3d=tb#<CR>
	Write	3D Sync Frame Sequential	<CR>*3d=fs#<CR>
	Write	3D Frame packing	<CR>*3d=fp#<CR>
	Write	3D Side by side	<CR>*3d=sbs#<CR>
	Write	3D inverter disable	<CR>*3d=da#<CR>

Function	Type	Operation	ASCII
Miscellaneous (continued)	Write	3D mode Off	<CR>*3dmode=off#<CR>
	Write	3D inverter	<CR>*3d=iv#<CR>
	Read	3D Sync Status	<CR>*3d=?#<CR>
	Read	Mac Address	<CR>*macaddr=?#<CR>
	Write	High Altitude mode on	<CR>*Highaltitude=on#<CR>
	Write	High Altitude mode off	<CR>*Highaltitude=off#<CR>
	Read	High Altitude mode status	<CR>*Highaltitude=?#<CR>
Color Calibration (service only)	Write	Set BenQ gamma value	<CR>*gamma=value#<CR>
	Read	Gamma value status	<CR>*gamma=?#<CR>
	Write	Set HDR Brightness value	<CR>*hdrbri=value#<CR>
	Read	Get HDR Brightness value	<CR>*hdibri=?#<CR>
	Write	Set Red Gain value	<CR>*RGain=value#<CR>
	Read	Get Red Gain value	<CR>*RGain=?#<CR>
	Write	Set Green Gain value	<CR>*GGain=value#<CR>
	Read	Get Green Gain value	<CR>*GGain=?#<CR>
	Write	Set Blue Gain value	<CR>*BGain=value#<CR>
	Read	Get Blue Gain value	<CR>*BGain=?#<CR>
	Write	Set Red Offset value	<CR>*ROffset=value#<CR>
	Read	Get Red Offset value	<CR>*ROffset=?#<CR>
	Write	Set Green Offset value	<CR>*GOffset=value#<CR>
	Read	Get Green Offset value	<CR>*GOffset=?#<CR>
	Write	Set Blue Offset value	<CR>*BOffset=value#<CR>
	Read	Get Blue Offset value	<CR>*BOffset=?#<CR>
	Write	Primary Color	<CR>*primcr=value#<CR>
	Read	Primary Color Status	<CR>*primcr=?#<CR>
	Write	Set Hue value	<CR>*hue=value#<CR>
	Read	Get Hue value	<CR>*hue=?#<CR>
	Write	Set Saturation value	<CR>*saturation =value#<CR>
	Read	Get Saturation value	<CR>*saturation =?#<CR>
	Write	Set Gain value	<CR>*gain=value#<CR>
Read	Get Gain value	<CR>*gain=?#<CR>	
Service (service only)	Write	Service mode enable for error report	<CR>*error=enable#<CR>
	Read	Error code report	<CR>*error=report#<CR>

Function	Type	Operation	ASCII
Service (service only) (continued)	Read	FAN 1 speed	<CR>*fan1=?#<CR>
	Read	FAN 2 speed	<CR>*fan2=?#<CR>
	Read	FAN 3 speed	<CR>*fan3=?#<CR>
	Read	FAN 4 speed	<CR>*fan4=?#<CR>
	Read	FAN 5 speed	<CR>*fan5=?#<CR>
	Read	Temperature 1	<CR>*tmp1=?#<CR>
	Read	Temperature 2	<CR>*tmp2=?#<CR>
	Read	Temperature 3	<CR>*tmp3=?#<CR>
	Read	LED indicator	<CR>*led=?#<CR>